

**MODEL 561
SCALAR NETWORK ANALYZER
OPERATION MANUAL**

WILTRON

490 JARVIS DRIVE • MORGAN HILL, CA 95037-2809
TEL. (408) 778-2000 • TELEX 285227 WILTRON MH • FAX 408-778-0239

P/N: 10410-00018
REVISION: B
PRINTED: APRIL 1988
COPYRIGHT 1988 WILTRON CO.

WARRANTY

All WILTRON products are warranted against defects in materials and workmanship for one year from the date of shipment, except for YIG-tuned oscillators, which are warranted for two years. WILTRON's obligation covers repairing or replacing products which prove to be defective during the warranty period. Buyers shall prepay transportation charges for equipment returned to WILTRON for warranty repairs. Obligation is limited to the original purchaser. WILTRON is not liable for consequential damages.

LIMITATION OF WARRANTY

The foregoing warranty does not apply to WILTRON connectors that have failed due to normal wear. Also, the warranty does not apply to defects resulting from improper or inadequate maintenance by the Buyer, unauthorized modification or misuse, or operation outside of the environmental specifications of the product. No other warranty is expressed or implied, and the remedies provided herein are the Buyer's sole and exclusive remedies.

CONTENTS

Paragraph	Title	Page
SECTION I — GENERAL INFORMATION		
1-1	SCOPE OF THE MANUAL	1-3
1-2	INTRODUCTION	1-3
1-3	IDENTIFICATION NUMBER	1-3
1-4	DESCRIPTION OF 561 SYSTEM	1-3
1-5	EQUIPMENT REQUIRED	1-4
1-6	OPTIONS	1-4
1-7	ACCESSORIES	1-4
1-8	SPECIFICATIONS	1-4
1-9	PRECAUTIONS FOR USE OF SWR AUTOTESTER AND RF DETECTORS	1-4
1-10	SYSTEM ELEMENTS	1-9
1-11	RECOMMENDED TEST EQUIPMENT	1-10
SECTION II — INSTALLATION		
2-1	INTRODUCTION	2-3
2-2	INITIAL INSPECTION	2-3
2-3	PREPARATION FOR USE	2-3
2-4	GPIB SETUP AND INTERCONNECTION	2-3
2-4.1	Interface Connector	2-3
2-4.2	Cable Length Restrictions	2-3
2-4.3	GPIB Interconnection	2-3
2-4.4	GPIB Address	2-5
2-4.5	Data Delimiting	2-5
2-5	SWEEP GENERATOR INTERCONNECTION	2-5
2-5.1	WILTRON 6600B Sweep Generator	2-5
2-5.2	Other Sweep Generators	2-5
2-6	PREPARATION FOR STORAGE AND/OR SHIPMENT	2-5
2-6.1	Preparation for Storage	2-5
2-6.2	Preparation for Shipment	2-5

CONTENTS (Continued)

Paragraph	Title	Page
SECTION III — LOCAL (CONTROL PANEL) OPERATION		
3-1	INTRODUCTION	3-3
3-2	CONTROL PANEL CONTROLS	3-3
3-2.1	CRT Display	3-3
3-2.2	SYSTEM FUNCTION Keys	3-4
3-2.3	DISPLAY Keys and Indicator	3-5
3-2.4	DATA ENTRY Keys and Knob	3-9
3-2.5	HARD COPY Keys	3-9
3-2.6	ENHANCEMENT Keys and Indicators	3-12
3-2.7	GPIB Indicator and Key	3-13
3-3	REAR PANEL CONNECTORS	3-14
3-4	MEASUREMENTS WITH THE 561 SCALAR NETWORK ANALYZER	3-14
3-4.1	Transmission and Return Loss Measurements	3-14
3-4.2	Absolute Power Measurement	3-14
3-4.3	Alternate Setup Measurements	3-14
3-5	OPERATIONAL CHECKOUT	3-14
3-6	ERROR MESSAGES	3-14
3-7	561 ANALYZER CONNECTIONS TO WILTRON SWEEP GENERATORS	3-14
SECTION IV — REMOTE (GPIB) OPERATION		
4-1	INTRODUCTION	4-3
4-2	DESCRIPTION OF THE IEEE-488 INTERFACE BUS	4-3
4-2.1	Data Bus Description	4-3
4-2.2	Management Bus Description	4-3
4-2.3	Data Byte Transfer Control (Handshake) Bus Description	4-4
4-3	GPIB OPERATION	4-4
4-4	COMMAND CODES, DESCRIPTIONS	4-4
4-4.1	Inputting Restrictions and Notes	4-4
4-4.2	Reserved Mnemonics	4-5
4-5	BUS MESSAGES, ANALYZER RESPONSE TO	4-5
4-6	ALPHABETICAL INDEX TO ANALYZER COMMAND CODES	4-5

List of Figures

Illustrations	Title	Page
Figure 1-1.	Models 561 Scalar Network Analyzer and 2225C Series Inkjet Printer	1-3
Figure 1-2.	Reading N Connector Pin Depth	1-5
Figure 1-3.	Pin Depth Gauge	1-5
Figure 2-1.	Changing the Analyzer LINE SELECT Switch	2-4
Figure 2-2.	GPIB Connector Panel	2-4
Figure 2-3.	GPIB Address Switch	2-5
Figure 3-1.	Model 561 Scalar Network Analyzer Front Panel Controls	3-2
Figure 3-2.	CRT Display	3-3
Figure 3-3.	SYSTEM FUNCTION Keys	3-4
Figure 3-4.	SAVE/RECALL Key Menus	3-4
Figure 3-5.	SYSTEM RESET Menu and Factory-Selected Settings	3-5
Figure 3-6.	DISPLAY Keys and Indicators	3-5
Figure 3-7.	DISPLAY MENU Key Menu	3-6
Figure 3-8.	OFFSET/RESOLUTION Key Menu	3-6
Figure 3-9.	LIMITS Key Menu	3-7
Figure 3-10.	CALIBRATION Key Menu Sequence	3-8
Figure 3-11.	DATA ENTRY Keys and Knob	3-9
Figure 3-12.	HARD COPY Keys	3-9
Figure 3-13.	HARD COPY Menus	3-10
Figure 3-14.	Hard Copy Examples	3-11
Figure 3-15.	ENHANCEMENT Keys and Indicators	3-12
Figure 3-16.	MOVE CURSOR TO CHANNEL PARAMETER Menus (with Δ off)	3-12
Figure 3-17.	MOVE CURSOR TO CHANNEL PARAMETERS Menu (with Δ on)	3-13
Figure 3-18.	AVERAGING Menu	3-13
Figure 3-19.	GPIB Indicator and Key	3-13
Figure 3-20.	GPIB Status Display	3-14
Figure 3-21.	Rear Panel Connections	3-15
Figure 3-22.	Measurement Test Setup	3-16
Figure 3-23.	Test Setup for Alternate Setup	3-21
Figure 3-24.	Test Setup for Ratio Mode Measurements	3-23
Figure 4-1.	Interface Connections and Bus Structure	4-2
Figure 4-2.	Typical Handshake Operation	4-4
Figure 4-3.	Programming Example: Complex Limits	4-7
Figure 4-4.	Programming Example: Service Request	4-10
Figure 4-5.	Redirected Status Byte	4-11

List of Figures

Illustrations	Title	Page
Figure 4-6.	Programming Example: SCP (mask)	4-13
Figure 4-7.	Available Parameters, OPM(X)	4-15
Figure 4-8.	Sample Program: RDR Command	4-18

List of Tables

Illustrations	Title	Page
Table 1-1	RF Component Pin Depth Tolerance	1-5
Table 1-2	Specifications	1-6
Table 1-3	SWR Autotesters	1-9
Table 1-4	560 Series Detector Parameters	1-10
Table 1-5	Recommended Test Equipment	1-11/1-12
Table 2-1	WILTRON International Sales Representatives	2-7/2-8
Table 3-1	Transmission and Return Loss Measurements	3-17
Table 3-2	Absolute Power Measurements	3-19
Table 3-3	Alternate Setup Measurements	3-20
Table 3-4	Operational Checkout Procedure	3-22
Table 3-5	Ratio Mode Measurements	3-23
Table 3-6	Control Panel LED Error Codes	3-25
Table 3-7	Interconnections, 561 to WILTRON and Other Sweep Generators	3-26
Table 4-1.	561 IEEE-488 Bus Subset Capability	4-5
Table 4-2	Command Codes: Display Channel Control	4-6
Table 4-3	Command Codes: Calibration, Graticule Display, System Functions, Diagnostic Facilities, Averaging, Smoothing	4-8
Table 4-4	Command Codes: Service Request	4-9
Table 4-5	Command Codes: Cursor Control and Search Facility	4-11
Table 4-6	Command Codes: Hard Copy	4-12
Table 4-7	Command Codes: Output Functions	4-14
Table 4-8	Command Codes: Data Strings	4-16
Table 4-9	Command Codes: Pass Through Codes	4-17
Table 4-10	Command Codes: General Functions	4-19
Table 4-11	Bus Messages Recognized By the 561	4-20
Table 4-12	Methods of Generating Bus Commands	4-21
Table 4-13	Alphabetical Index to the Command Codes	4-22

SECTION I GENERAL INFORMATION

CONTENTS

Paragraph	Title	Page
1-1	SCOPE OF THE MANUAL	1-3
1-2	INTRODUCTION	1-3
1-3	IDENTIFICATION NUMBER	1-3
1-4	DESCRIPTION OF 561 SYSTEM	1-3
1-5	EQUIPMENT REQUIRED	1-4
1-6	OPTIONS	1-4
1-7	ACCESSORIES	1-4
1-8	SPECIFICATIONS	1-4
1-9	PRECAUTIONS FOR USE OF SWR AUTOTESTER AND RF DETECTORS	1-4
1-10	SYSTEM ELEMENTS	1-9
1-11	RECOMMENDED TEST EQUIPMENT	1-10



SECTION I GENERAL INFORMATION

1-1 SCOPE OF THE MANUAL

This manual provides general, installation, and operation information for the Model 561 Scalar Network Analyzer (Figure 1-1).

1-2 INTRODUCTION

Section I provides information about the equipment identification number, performance specifications, and options.

1-3 IDENTIFICATION NUMBER

All WILTRON instruments are assigned a six-digit ID number, such as "505001." This number appears on a decal affixed to the rear panel. Please use this

identification number in any future correspondence with WILTRON Customer Service about this instrument

1-4 DESCRIPTION OF 561 SYSTEM

The 561 Scalar Network Analyzer is a microprocessor based receiver used to make scalar (magnitude) reflection and transmission measurements and absolute power measurements over a frequency range determined by the source sweeper and the external detectors used. The 561 is programmable over the GPIB, IEEE-488 interface bus, and also because of the extensive use of internal microprocessors, the 561 can be used to make the majority of measurements without an external controller.



Figure 1-1. Model 561 Scalar Network Analyzer and 2225C Series Inkjet Printer

1-5 EQUIPMENT REQUIRED

The Model 561 Scalar Network Analyzer system requires interconnection with a sweep generator to provide the necessary horizontal, dwell and blanking voltages. The 561 is designed for use with the WILTRON 6600B Series Programmable Sweep Generator and is supplied with a dedicated system bus cable (PN 2100-1) and auxillary I/O cable (PN 870-7). It is also compatible with other sweep generators that meet the SIGNAL SOURCE Compatibility requirements in Table 1-2.

1-6 OPTIONS

The following options are available:

Option 1, Rack Mount. A kit is available containing mounting brackets and chassis track slides. The track slides have a 90-degree tilt capability.

Option 5, Protective Cover. The 561 Scalar Network Analyzer is available with a protective cover, WILTRON P/N: SPEC-D-31359-3, for the control (front) panel.

1-7 ACCESSORIES

The following accessories are available for the 561 Scalar Network Analyzer:

Extender Cables. Extender cables can be installed between the SWR Autotester or detectors and the 561, permitting measurements from up to 200 feet. Cable part numbers and lengths are shown below.

Model	Cable Length
800-109	7.6m (25 ft)
800-110	15.2m (50 ft)
800-111	30.5m (100 ft)
800-112	61m (200 ft)

GPIB Cables. GPIB cables interconnect instruments on the GPIB. GPIB cable part numbers and lengths are shown below.

Model	Cable Length
2100-1	1m (3.3 ft)
2100-2	2m (6.6 ft)
2100-4	4m (13.2 ft)
2100-5	0.5m (1.65 ft)

Adapter Cables. Adapter cables allow the 561 to be used with a waveguide or other detectors having a BNC or SMA female output connector. The cable

length is 1.2 m (4 ft). Part number and connector type are shown below.

Model	Connector
560-10BX	BNC Male
560-10BX-1	SMA Male
(for use with Hughes detectors)	

Open/Shorts. An Open/Short is used to establish a 0 dB return loss reference during the calibration procedure. Model part numbers and connector types are shown below.

Model	Connector
21A-1*	GPC-7 Short Only
22A50	GPC-7
22K50	K Male
22KF50	K Female
22N50	N Male
22NF50	N Female
22S50	WSMA Male
22SF50	WSMA Female

* Supplied with collet for use with 18A50 beadless test port.

1-8 SPECIFICATIONS

Specifications for the 561 Scalar Network Analyzer and the 560 Series SWR Autotesters and RF Detectors are provided in Table 1-2.

1-9 PRECAUTIONS FOR USE OF SWR AUTOTESTER AND RF DETECTORS

The 560 Series SWR Autotester and RF Detectors (RF Components) are high-quality, precision laboratory instruments and should receive the same care and respect afforded other such instruments. Complying with the following precautionary notes will guarantee longer component life and less equipment downtime due to connector failure. Also, such compliance will ensure that RF component failures are not due to misuse or abuse—two failure causes not covered under the WILTRON warranty.

a. Beware of destructive Pin Depth on Mating Connectors

Measure the pin depth (Figure 1-2) of the connector that mates with the RF component before mating using a WILTRON Pin Depth Gauge (Figure 1-3) or equivalent. Based on RF components returned for repair, destructive pin depth on mating connectors is the major cause of failure in the field. When an RF component connector is mated with a connector having a destructive pin depth, damage will likely occur to

the RF component connector. (A destructive pin depth has a center pin that is too long in respect to the connector's reference plane.)

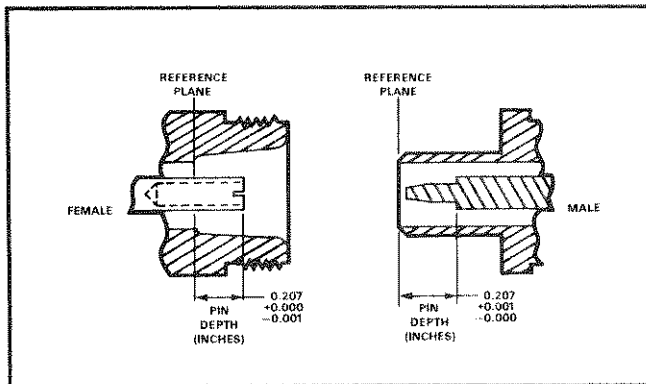

Figure 1-2. Reading N Connector Pin Depth

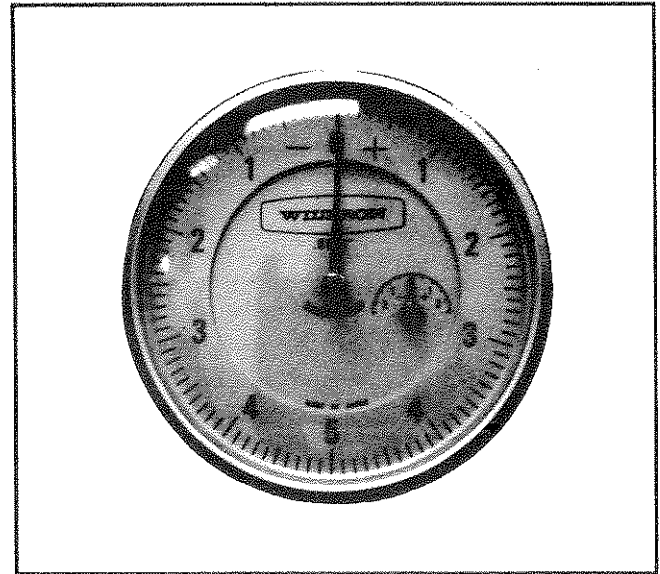

Figure 1-3. Pin Depth Gauge

The center pin on an RF component connector has a precision tolerance measured in mils (1/1000 inch), whereas connectors on test devices that mate with RF components may not be precision types, and their pins may not have the proper depth. Consequently, they must be measured before mating to ensure suitability. When gauging pin depth, if the test device connector measures out of tolerance (Table 1-1) in the "+" region, the center pin is too long. Mating under this condition will probably damage the RF component connector. On the other hand, if the test device connector measures out of tolerance in the "-" region, the center pin is too short. A mating, while not causing any damage, will however result in a poor connection and a consequent degradation in performance.

Table 1-1. RF Component Pin Depth Tolerance

Test Port Connector Type	Pin Depth (Mils)	Wiltron Gauge Reading
N-Male	207 -0.000 +0.003	210 -0.000 +0.003
N-Female	207 +0.000 -0.003	same as pin depth

b. Avoid Over-Torquing Connectors

Over-torquing connectors is destructive; it may damage the connector center pin. Finger-tight is usually sufficient, especially on type N connectors. Never use pliers to tighten connectors.

c. Do Not Disturb Teflon Tuning Washers On Connector Center Pins

The center conductor on many RF component connectors contains a small teflon tuning washer located near the point of mating (interface). This washer compensates for minor impedance discontinuities at the interface. The washer's location is critical to the RF component's performance. Do Not Disturb.

d. Avoid Mechanical Shock

RF components are designed to withstand years of normal bench handling. However, do not drop or otherwise roughly treat them. They are laboratory-quality devices, and like other such devices, they require careful handling.

e. Keep Connectors Clean

The precise geometry that makes possible the RF component's high performance can be easily disturbed by dirt and other contamination adhering to connector interfaces. When not in use, keep the connectors covered.

Table 1-2. Specifications (1 of 3)

MEASUREMENTS

Measurement Modes: Measures and displays in dB swept transmission and return loss characteristics. Power is displayed in dBm. Complete measurement parameters for all modes are displayed.

Frequency Range: 10 MHz to 40 GHz in coax using WILTRON 560 Series Detectors and SWR Autotesters. Measurements can be made at higher frequencies with user-supplied waveguide detectors and WILTRON 560-10BX or 560-10BX-1 Adapter Cables.

Inputs: Four inputs, A, B, R1, and R2 accept detected outputs from WILTRON 560 Series Detectors and SWR Autotesters.

Dynamic Range: 71 dB (-55 dBm to +16 dBm) on all channels, usable to -60 dBm. Noise floor is typically less than -62 dBm.

Data Correction: System residuals, including the average of open and short reflections, are stored during calibration for automatic subtraction from test data.

Calibration: During the calibration sequence, 2001 points for each trace are stored with 0.002 dB resolution over any user-selected frequency range. Calibration data are automatically interpolated for ranges less than the original normalized range.

Save/Recall: Nine sets of front-panel settings, or four sets with calibration data, can be stored for later recall. All stored data can be previewed on the CRT or printer output prior to selection.

DISPLAY

Channels: Two channels are used to select and simultaneously display any two inputs from A, B, R1, or R2. The same inputs can be displayed as ratios of A/R1, A/R2, B/R1, or B/R2.

Alternate Sweep: Displays alternate sweeps between the current front-panel setup and any of nine stored setups when used in conjunction with the 6600B Sweep Generator.

Graticule: Ten vertical divisions. Horizontal divisions are set automatically in frequency increments of a 1, 2, 5 sequence. The graticule On/Off control turns all graticule lines off. Tick marks remain on each axis to indicate graticule position.

Display Resolution:

Horizontal: 101, 201, or 401 points per trace over the selected frequency range.

Vertical: 0.005 dB

Limit Lines: Two lines for each trace can be set as go/no-go data limits. By switching off the standard graticule and activating the DISPLAY LIMITS switch, a custom graticule can be constructed with the limit lines and frequency markers via the DATA ENTRY switches. Limit lines may be either horizontal or complex.

SCALING

Resolution: 0.1 dB to 10 dB per division in 0.1 dB steps with independent control for each channel.

Offset Range: -99 dB to +99 dB in 0.1 dB steps.

Autoscale: Automatically selects offset and resolution to provide optimum display of test data.

Trace Update Time: Typically less than 100 ms, varying with frequency range, averaging and smoothing settings, and number of data points selected.

Smoothing: Off, Minimum, and Maximum selections use analog techniques to reduce noise on low-level traces. Trace update time is automatically adjusted for any combination of averaging and smoothing.

Averaging: 4, 8, 16, 32, 64, 128, or 256 successive traces can be averaged to smooth the trace display.

CRT Intensity: Variably adjustable from off to bright.

MARKERS AND CURSORS

Main Cursor: Variably adjusted via the DATA ENTRY tuning knob, or moved in discrete steps by the ENHANCEMENT CH1 and CH2 switches in conjunction with the MENU SELECT switch. The discrete cursor movements are as follows:

Min/Max: Selecting menu option minimum or maximum will move the cursor directly to that value of test data on the trace selected.

"X" dB: Automatically moves the cursor to the amplitude on the trace where the test data is equal to the "X" dB (dBm) value entered via the DATA ENTRY keypad or tuning knob.

"X" Bandwidth: Additional cursors are displayed to the right and left of the main cursor at the frequencies where the test data is equal to the "X" dB (dBm) value entered via the DATA ENTRY keypad or tuning knob.

Next Marker: Moves the cursor to the next highest frequency marker (see markers below).

Table 1-2. Specifications (2 of 3)

Active Marker: Moves the cursor to the frequency of the active marker.

Delta Cursor: Displays the differences in dB and frequency between the Reference Cursor (previous main cursor position) and the new main cursor position. This is attained by adjusting the DATA ENTRY tuning knob, or by adjusting the ENHANCEMENT CH1 and CH2 switches in conjunction with the MENU SELECT switch.

Markers: Up to eight numerically identified markers generated by the 6600B Sweep Generator may be displayed on the 561. Marker frequency and type are selected on the 6600B. A marker is designated as "Active" if it is open to DATA ENTRY.

SIGNAL SOURCE

Recommended Signal Source: The WILTRON 6600B Sweep Generators are directly compatible with the 561. A dedicated GPIB system interface supplies frequency annotation on the 561 display.

Compatibility: The 561 is compatible with any signal source that meets the following minimum requirements:

- Horizontal Ramp: Provides a 0V to +10V nominal ramp signal, +12 V maximum.
- Blanking Signal: Provides + 5V during retrace and bandswitching "e.g." Wiltron Seq Sync signal.
- Dwell Signal: Outputs TTL-low signal to dwell sweep ramp.

ACCURACY

Transmission Loss or Gain Accuracy: Uncertainties from frequency response of components are

Channel Accuracy (25°C)

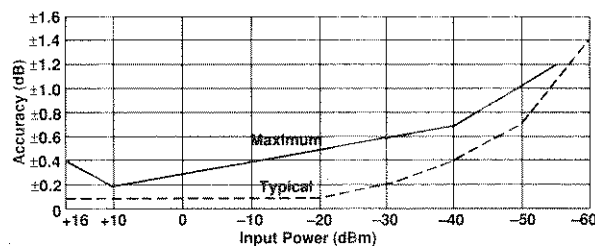

automatically subtracted from test data during the calibration procedure. Overall accuracy is then:
**Effects of sweep generator, test device, SWR Autotester and detector mismatch can be significant. This mismatch*

$$\text{Transmission Loss or Gain Accuracy} = \text{Channel Accuracy} + \text{Mismatch Uncertainty}^*$$

**Uncertainty is minimized by Wiltron's exceptionally low reflection characteristics of the detector, sweep generator and SWR Autotester.*

Overall Coaxial Return Loss Measurement Accuracy: Uncertainties resulting from SWR Autotester Mismatch Uncertainty (Typical)*

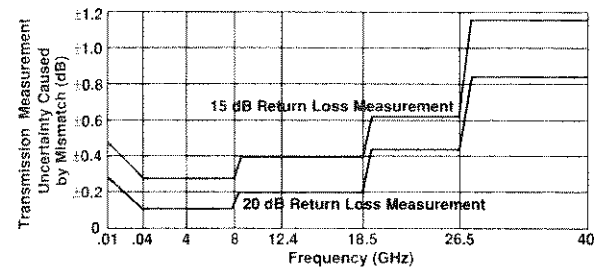

**Varies with the return loss of the detector, SWR Autotester, connecting cables, the source impedance of the sweep generator, and the value of the measured reflection.*

and sweep generator frequency response and from system open and short characteristics are automatically subtracted from test data. Overall accuracy is then:

$$\text{Return Loss Accuracy} = \text{Channel Accuracy} + \text{SWR Autotester Accuracy}$$

SWR Autotester Accuracy:

Model	Accuracy of Measured Reflection Coefficient (ρ)**			
	10 MHz-8 GHz	8-18 GHz	18-26.5 GHz	26.5-40 GHz
560-97A50	0.016±0.06ρ ²	0.016±0.1ρ ²	N/A	N/A
560-97A50-1	0.010±0.06ρ ²	0.010±0.1ρ ²	N/A	N/A
560-97N50	0.018±0.08ρ ²	0.018±0.12ρ ²	N/A	N/A
560-97N50-1	0.013±0.08ρ ²	0.013±0.12ρ ²	N/A	N/A
560-97NF50	0.018±0.08ρ ²	0.018±0.12ρ ²	N/A	N/A
560-97NF50-1	0.013±0.08ρ ²	0.013±0.12ρ ²	N/A	N/A
560-98K50	0.018±0.15ρ ²	0.018±0.15ρ ²	0.025±0.15ρ ²	0.032±0.18ρ ²
560-98KF50	0.018±0.15ρ ²	0.018±0.15ρ ²	0.025±0.15ρ ²	0.032±0.18ρ ²
560-98S50	0.018±0.1ρ ²	0.018±0.1ρ ²	0.025±0.12ρ ²	N/A
560-98S50-1	0.013±0.1ρ ²	0.013±0.1ρ ²	0.018±0.12ρ ²	N/A
560-98SF50	0.018±0.1ρ ²	0.018±0.1ρ ²	0.025±0.12ρ ²	N/A
560-98SF50-1	0.013±0.1ρ ²	0.013±0.1ρ ²	0.018±0.12ρ ²	N/A

***Accuracy includes the effects of directivity and test port reflection over the frequency range.*

Table 1-2. Specifications (3 of 3)

Overall Waveguide Return-Loss Measurement Accuracy:

$$\text{Return Loss Accuracy} = \text{Channel Accuracy} + \text{User-Selected Coupler Accuracy}$$

In addition, mismatch uncertainties introduced by the detectors used in a waveguide reflectometer setup can be significant.

Power Measurement Accuracy:

$$\text{Absolute Power Accuracy} = \text{Channel Accuracy} + \text{Detector Frequency Response}$$

Detector Frequency Response:

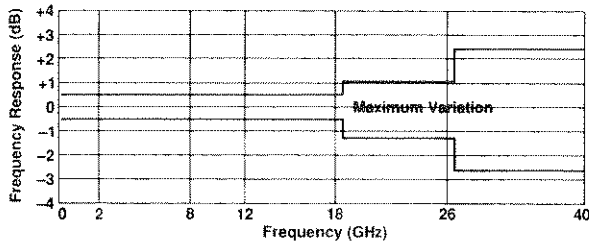

GPIB

Interface: IEEE-488 interface is standard on all instruments. All front panel controls are GPIB controllable except power on/off and CRT intensity. A dedicated GPIB connects to a WILTRON 6600B Sweep Generator. Pass-through commands allow control of the signal source through the 561 dedicated GPIB port.

Data Transfer: The 561 does not require an external controller for most measurements; nevertheless, it is capable of providing high speed transfer of test data and normalization data to and from an external GPIB controller.

PRINTER/PLOTTER

Printer: The parallel printer interface is compatible with most dot-matrix printers, including Epson FX and HP Thinkjet. Hard copy output in graphical or tabular format can be selected. Selections include graphics with measurement parameters, test data tabulated for 26, 51, 101, 201, or 401 points, marker parameters only, or stored setup parameters.

Plotter: The dedicated system GPIB interface is compatible with HP Models 7440A, 7470A, and 7475A Plotters. Display traces, markers, cursor, and graticule information are copied. When overlay traces are desired, data traces only can be plotted.

Internal Print Buffer: After approximately 10 seconds of print formatting, a new test can be conducted while previously taken test data are being printed out from an internal printer buffer.

INPUT/OUTPUT CONNECTIONS

Horizontal Sweep Ramp Input: 0 to +10V nominal, +12V maximum. Rear panel BNC connector, 100K ohm impedance.

Sequential Sync Input: +3.5V to +10V blanks trace during retrace or bandswitching. -3.5V to -10V defines a marker which when in the range of -8V to -10V is an active marker. Rear panel BNC connector, 10K ohm impedance.

Sweep Dwell Output: TTL-low signal stops sweep. Sweep continues when signal is removed. Rear panel BNC connector.

Bandswitch Blanking Input: Accepts ±5V signal coincident with bandswitching points. Rear panel BNC connector.

Retrace Blanking Input: ±5V blanks traces during retrace. Rear panel BNC connector.

Video Marker Input: ± 2V to ±10V peak input. Rear panel BNC connector.

GPIB IEEE 488: Connects 561 to GPIB or plotter. Rear panel GPIB connector.

Dedicated GPIB: Connects 561 to WILTRON signal source and plotter. Rear panel GPIB connector.

Parallel Printer (Centronics): Connects 561 to printer. Rear panel.

AUX I/O: Connects 561 to WILTRON 6600B Sweep Generator. Rear panel.

Composite Video: External display signal from rear panel, BNC connector.

GENERAL

Temperature Range:

Operating: 0°C to +50°C

Storage: -40°C to +70°C

Power: 100V/110V/220V/240V ±10%, 48-63 Hz, 130 VA maximum

Dimensions:

177H x 432W x 476D MM + 10mm for feet.

(7H x 17W x 18-3/4D in. + 3/8 in. for feet)

Weight: 16 kg (35 lb)

1-10 SYSTEM ELEMENTS

a. Network Analyzer

The 561 Scalar Network Analyzer provides a simultaneous display of transmission loss/gain and return loss or power. A complete measurement system includes a signal source, a 560 Series SWR Autotester and Detector (Note: 6400 Series Autotesters and Detectors may also be used). Interface with waveguide detectors is provided by the 560-10BX or 560-10BX-1 Adapter Cables. The system makes direct connection to a printer or plotter and does not require an external controller.

b. Signal Source

The 561 is compatible with the Wiltron 6600B Sweep Generators or other signal sources that meet the interface requirements listed under SIGNAL SOURCE Compatibility in Table 1-2.

c. SWR Autotester

The 560 Series SWR Autotesters (Table 1-3) integrate in one small package a broadband, high directivity bridge, a detector, a low reflection test port, a reference termination, and a connecting cable. The output of the SWR Autotester is a detected signal, varying in proportion to reflections from the test device connected to the test port. Optional extender cables can be used without degradation in performance.

Accuracy: See accuracy chart on page 1-7.

Maximum Input Power: 500 mW

Cable Length: 122 cm (4 ft)

Insertion Loss: 6.5 dB nominal from input port to test port.

Dimensions and Weight:

Model	Dimensions*	Weight
560-97A50, -1	7.6 x 5 x 2.8 cm	340 g
560-97N50, -97NF50, -1	(3 x 2 x 1-1/8 in.)	
560-98K50, -98KF50	5.3 x 3.8 x 1.9 cm	198 g
560-98S50, -98SF50, -1	(2-1/8 x 1-1/2 x 3/4 in.)	

*Plus Connectors and cable.

d. Detector

The 560 Series Detectors (Table 1-4) are used for coaxial transmission loss or gain, power measurements, and with coaxial adapters for waveguide reflectometer measurements. Zero-biased, replaceable Schottky diodes provide -60 dBm sensitivity. Optional extender cables can be used without degradation in performance. Field replacement of the detector diode is possible with most of the 560-7 Series RF Detectors.

Maximum Input Power: 100 mW

Cable Length: 122 cm (4 ft)

Dimensions: 7.6 x 2.9 x 2.2 cm (3 x 1-1/8 x 7/8 in.)

Weight: 170 g (6 oz)

Table 1-3. SWR Autotesters

Model	Frequency Range (GHz)	Directivity (dB)	Frequency Sensitivity (dB)	Test Port Connector	Input Connector
560-97A50 560-97A50-1	0.01—18	36 40	±1.2	GPC-7	N Female
560-97N50 560-97N50-1	0.01—18	35 38	±1.5	N Male	N Female
560-97NF50 560-97NF50-1	0.01—18	35 38	±1.5	N Female	N Female
560-98S50 560-98S50-1	0.01—26.5	32 35	±2	WSMA Male	Ruggedized WSMA Female
560-98SF50 560-98SF50-1	0.01—26.5	32 35	±2	WSMA Female	Ruggedized WSMA Female
560-98K50 560-98KF50	0.01—40	30 30	±3	K Male K Female	Ruggedized K Female

Replaceable Diode Modules:

Table 1-4. 560 Series Detector Parameters

Model	Frequency Range	Input Connector	Diode Module Model
560-7A50	10 MHz to 18GHz	GPC-7	560-A-7219-A
560-7K50	10 MHz to 40 GHz	K Male	Factory Repair Only
560-7N50	10 MHz to 18.5 GHz	N Male	560-A-7219-A
560-7S50	10 MHz to 18.5 GHz	WSMA Male	560-A-7219-A
560-7S50-2	10 MHz to 26.5 GHz	WSMA Male	560-A7219-B
560-7S50-3	10 MHz to 34 GHz	WSMA Male	560-A-7219-C

Detector Return Loss:

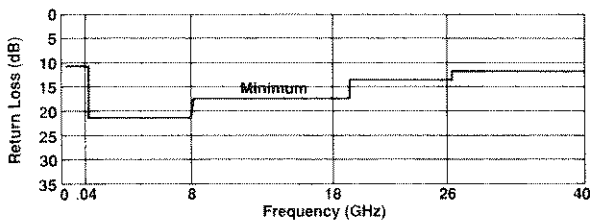

1-11 RECOMMENDED TEST EQUIPMENT

Table 1-5 provides a list of recommended test equipment needed to check, calibrate, service, and troubleshoot the 561 Scalar Network Analyzer. The entries are coded to show for which types of testing the equipment is used. These codes are described below.

Code	Type of Testing
C	Calibration
O	Operational Checkout
P	Performance Verification
T	Troubleshooting

Table 1-5. Recommended Test Equipment

INSTRUMENT	CRITICAL SPECIFICATION	RECOMMENDED MANUFACTURER	USE *
Power Meter	<i>Power Range:</i> -30 to +20 dBm <i>Other:</i> GPIB Controllable	Hewlett-Packard, Model 436A, with Opt 022 (HPIB)	O, P, C
Power Sensor (i)	<i>Frequency Range:</i> 0.01 to 18 GHz <i>Power Range:</i> + 16 to -20 dBm	Hewlett-Packard, Model 8481A	O, P, C
Power Sensor (ii)	<i>Power Range:</i> -20 to -60 dBm	Hewlett-Packard, Model 8484A	O, P, C
Digital Multimeter	Resolution: 4-1/2 digits (to 20V) <i>DC Accuracy:</i> 0.002% + 2 counts <i>DC Input Impedance:</i> 10 M Ω <i>AC Accuracy:</i> 0.07% + 100 counts (to 20 kHz) <i>AC Input Impedance:</i> 1 megohm	John Fluke, Inc., Model 8840A, with Option 8840A-09 True RMS AC	T
Oscilloscope	<i>Bandwidth:</i> DC to 150 MHz <i>Sensitivity:</i> 2 mV <i>Horiz. Sensitivity:</i> 50 ns/division	Tektronix, Inc. Model 2445	O, P, C, T
Sweep Generator	<i>Horizontal Output:</i> 0 to 10V Sweep Dwell, Seq Sync lines as defined in Table 1-1, 50 MHz, +10 dBm	WILTRON 6647B	O, P, C
Step Attenuator	60 dB range	WILTRON HP 355D	P, C

*C-Calibration, O-Operational, P-Performance, T-Troubleshooting

SECTION II INSTALLATION

CONTENTS

Paragraph	Title	Page
2-1	INTRODUCTION	2-3
2-2	INITIAL INSPECTION	2-3
2-3	PREPARATION FOR USE	2-3
2-4	GPIB SETUP AND INTERCONNECTION	2-3
2-4.1	Interface Connector	2-3
2-4.2	Cable Length Restrictions	2-3
2-4.3	GPIB Interconnection	2-3
2-4.4	GPIB Address	2-5
2-4.5	Data Delimiting	2-5
2-5	SWEEP GENERATOR INTERCONNECTION	2-5
2-5.1	WILTRON 6600B Sweep Generator	2-5
2-5.2	Other Sweep Generators	2-5
2-6	PREPARATION FOR STORAGE AND/OR SHIPMENT	2-5
2-6.1	Preparation for Storage	2-5
2-6.2	Preparation for Shipment	2-5

SECTION II INSTALLATION

2-1 INTRODUCTION

This section provides information on initial inspection, preparation for use, General Purpose Interface Bus (GPIB) interconnections and sweep generator interconnections. It also includes reshipment and storage information.

2-2 INITIAL INSPECTION

Inspect the shipping container for damage. If the container or cushioning material is damaged, retain until the contents of the shipment have been checked against the packing list and the instrument has been checked for mechanical and electrical operation.

If the analyzer is damaged mechanically, notify your local sales representative or WILTRON Customer Service. If either the shipping container is damaged or the cushioning material shows signs of stress, notify the carrier as well as WILTRON. Keep the shipping materials for the carrier's inspection.

2-3 PREPARATION FOR USE

Preparation for use consists of checking for the correct line voltage. The line voltage selector on the rear panel enables the analyzer to be used with either 100, 120, 220, or 240Vac. Before leaving the factory, each analyzer is preset and tagged for the line voltage present in the customer's area. If the actual line voltage is different from that stated on the tag, change the LINE SELECT switch (Figure 2-1) to the correct setting and the line fuses to the correct value.

2-4 GPIB SETUP AND INTERCONNECTION

The analyzer provides automated microwave measurements via the GPIB. The following paragraphs provide information about interface connections, cable requirements, and the addressing of the analyzer.

2-4.1 Interface Connector

Interface between the analyzer and other devices on the GPIB is via a 24-wire interface cable. This cable uses connector shells having two connector faces. These double-faced connectors allow for the parallel connection of two or more cables to a single device. Figure 2-2 shows the pin assignments for the Type 57 GPIB connector installed on the rear panel.

2-4.2 Cable Length Restrictions

The GPIB system can accommodate up to 15 instruments at any one time. To achieve design performance on the bus, proper timing and voltage level relationships must be maintained. If either the cable length between separate instruments or the accumulated cable length between all instruments is too long, the data and control lines cannot be driven properly and the system may fail to perform. Cable length restrictions are as follows:

- No more than 15 instruments may be installed on the bus.
- Total accumulative cable length in meters may not exceed two times the number of bus instruments or 20 meters—whichever is less.

NOTE

For low EMI applications, the GPIB cable should be a fully shielded type, with well-grounded metal-shell connectors

2-4.3 GPIB Interconnection

The only interconnection required for GPIB operation is between the analyzer and the controller. This interconnection is via a special GPIB cable. The WILTRON Part number for such a cable is 2000-1, -2, or -4 (1, 2, or 4 meters in length).

To change the line voltage from that shown on the Line Voltage Selector Module, proceed as follows:

- (a) Remove the power cord from the line voltage module.
- (b) Insert the blade of a small screwdriver into the slot at the top-center of the module, and pry open the cover.
- (c) Remove the voltage selector drum by pulling straight out.
- (d) Rotate the drum so that the desired line voltage marking faces out, then reinstall the drum.
- (e) Remove the fuse cartridge from the right-hand fuseholder. The fuse cartridge is identified with a white arrow and is located beneath the voltage selector drum.
- (f) Check that the proper fuse is installed (see table).
- (g) Change to the correct fuse, if necessary, and replace the fuse cartridge.
- (h) Close the cover, and ensure that the desired line voltage value is displayed through the opening in the cover.
- (i) Reinstall the line cord.

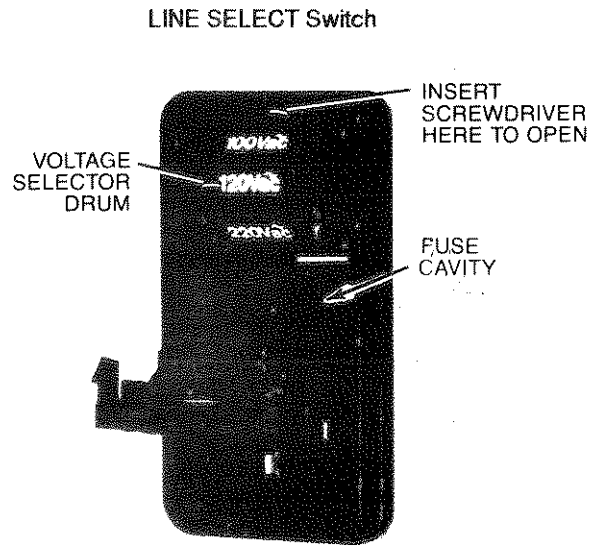

Fuse Sizes, Ratings, and Part Numbers

Line Voltage	Area	Fuse Rating	Fuse Size	Wiltron P/N-Fuse	Wiltron P/N-Fuse Holder
100 Vac	Japan	2A, antisurge	3 AG	631-52	533-221
120 Vac	USA	2A, antisurge	3 AG		
220 Vac	Europe	1A, antisurge	5 x 20 mm	631-49	553-240
240 Vac	UK	1A, antisurge	5 x 20 mm		

Figure 2-1. Changing the Analyzer LINE SELECT Switch

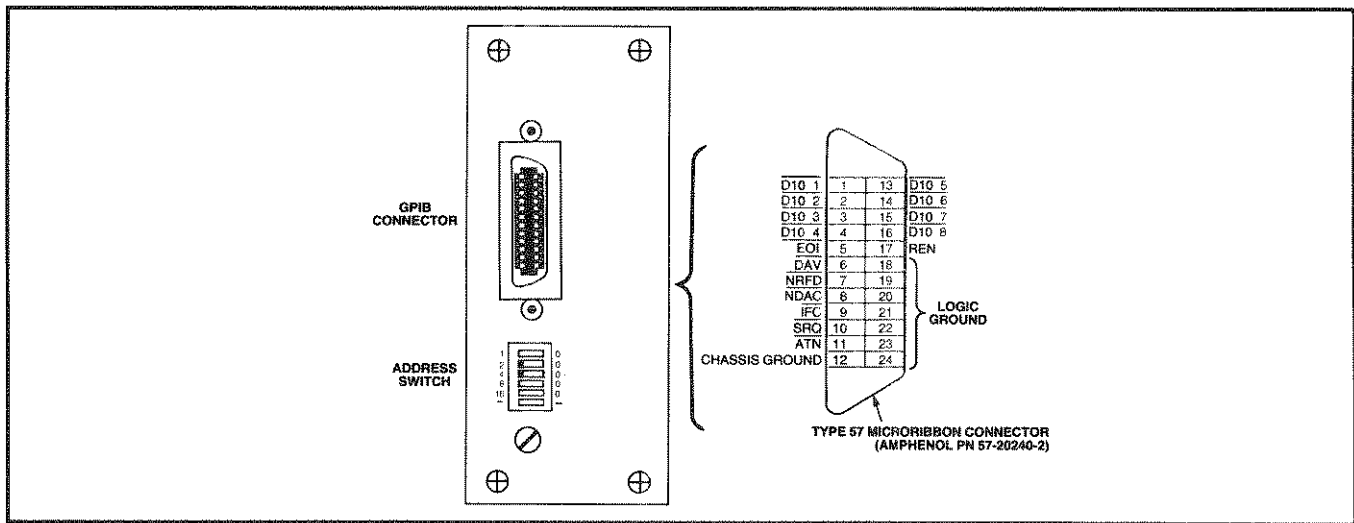

Figure 2-2. GPIB Connector Panel

2-4.4 GPIB Address

The analyzer leaves the factory preset to address 6. If a different address is desired, it can be set by changing the GPIB address switches on the rear panel (Figure 2-3). After making an address change, be sure to press the "RETURN TO LOCAL" key to activate the new address.

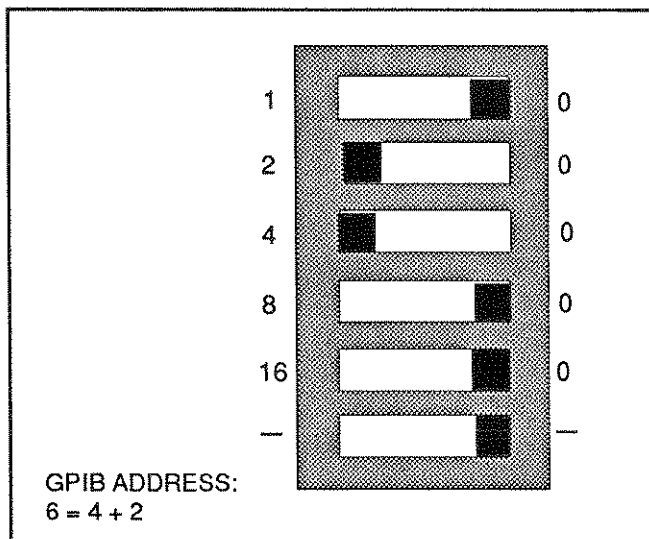

Figure 2-3. GPIB Address Switch

2-4.5 Data Delimiting

Data used for the input and output functions of the 561 are terminated as follows:

a. Output Functions of the 561:

- End of all output binary data strings are terminated with EOI (End or Identify) true.
- End of all output ASCII data strings are terminated with CR LF and EOI. The EOI provides complete data termination and is sent with the LF character.

b. Input Functions of the 561:

- All binary data strings received by the 561 must be terminated with EOI true with the last data byte.
- All ASCII data strings received by the 561 must be terminated with either EOI, LF and EOI, CR LF, or CR LF and EOI.

2-5 SWEEP GENERATOR INTERCONNECTION

Paragraphs 2-5.1 and 2-5.2 give instructions for connecting the 561 Network Analyzer to various sweep generators.

2-5.1 WILTRON 6600B Sweep Generator

The 561 Analyzer is supplied with a dedicated system bus cable (PN 2100-1) and auxiliary I/O cable (PN 870-7) for use with a 6600B Sweep Generator. After turning power off for both the 561 and 6600B, install the I/O cable between the AUX I/O connectors of both devices. Next connect the system bus cable between the Dedicated System GPIB connector of the analyzer and the IEEE-488 Interface connector of the sweep generator. The system is now ready for operation.

2-5.2 Other Sweep Generators

The 561 Analyzer requires interconnection with a sweep generator capable of supplying the necessary horizontal, blanking, and dwell signals specified in Table 1-2 Signal Source Compatibility (See Section III, Table 3-7 for instructions on interconnecting the 561 to other WILTRON sweep generators using BNC to BNC).

2-6 PREPARATION FOR STORAGE AND/OR SHIPMENT

Paragraphs 2-6.1 and 2-6.2 give instructions for preparing the analyzer for storage or shipment.

2-6.1 Preparation for Storage

Preparing the analyzer for storage consists of cleaning the unit, packing the inside with moisture-absorbing dessicant crystals, and storing the unit in a temperature environment that is maintained between -40 and $+70$ degrees centigrade.

2-6.2 Preparation for Shipment

To provide maximum protection against damage in transit, the analyzer should be repackaged in the original shipping container. If this container is no longer available and the analyzer is being returned to WILTRON for repair, advise WILTRON Customer Service; they will send a new shipping container free

of charge. In the event neither of these two options is possible, instructions for packaging and shipment are given below.

a. Use a Suitable Container.

Obtain a corrugated cardboard carton with a 275-pound test strength. This carton should have inside dimensions of no less than six inches larger than the instrument dimensions to allow for cushioning.

b. Protect the Instrument.

Surround the instrument with polyethylene sheeting to protect the finish.

c. Cushion the Instrument.

Cushion the instrument on all sides by tightly packing dunnage or urethane foam between the carton and the instrument. Provide at least three inches of dunnage on all sides.

d. Seal the Container.

Seal the carton by using either shipping tape or an industrial stapler.

e. Address the Container.

If the instrument is being returned to WILTRON for service, mark the WILTRON address and your return address on the carton in one or more prominent locations. For international customers, use the address of your local representative (Table 2-1). For U.S.A. customers, use the WILTRON address shown below:

WILTRON Company
ATTN: Customer Service
490 Jarvis Drive
Morgan Hill, CA 95037-0289.

Table 2-1. WILTRON International Sales Representatives

ARGENTINA I.A. ELECTRONICA S.R.L. T.C. de Allende 430 5000 Cordoba Telephone: (051) 32150/34815 Telex: 390 51894 ENTOP AR	FINLAND INSTRUMENTARIUM ELEKTRONIIKKA P.O. Box 64, Vitikka 1 SF-02631 ESPOO Telephone: 358 (0) 5281 Telex: 857-124426 HAVUL or 857-8100155 INSTRUE Teletex: 100155 Fax: (0) 524986	IRELAND (Southern) ATRON ELECTRONICS LTD. (Avelec Group) Lynwood House, Ballinteer Road, Dublin 16 Telephone: 353-1-988433/988798 Telex: 852-90662 ATRN EI	NEW ZEALAND S.D. MANDENO ELECTRONIC EQUIP. CO. 10 Woodhall Road, Epsom, Auckland 3 Telephone: (9) 600008 Fax: (9) 601720 Cable: NUCLEONIC Auckland	SPAIN UNITRONICS, S.A. Plaza Espana, 18 Torre de Madrid Pl. 12, Ofc. 9, Madrid Telephone: (01) 2425204 Telex: 831-46786 Fax: (01) 2484228 (Madrid) (03) 3226800 (Barcelona)
AUSTRALIA KENELEC (AUST.) PTY. LTD. 48 Henderson Road Clayton, Victoria 3168 Telephone: (03) 5601011 Telex: 790-35703 Fax: (03) 5601806	FRANCE ELEXIENNE 9, rue des Petits Ruisseaux 91370 Verrieres le Buisson Telephone: (1) 60-11-94-71 Telex: 842-691789 F Fax: (1) 60-11-98-09	ISRAEL RACOM ELECTRONICS, LTD. P.O. Box 21120 Tel Aviv 61210 7 Kehilat Saloniki St, Tel Aviv 69513 Telephone: (3) 491922 Telex: 922-33808 Fax: (3) 491576	NORWAY HUGO RISO A/S TEKNISK IMPORT P.O. Box 33 Voksensbogen N-0708 Oslo 7 Telephone: (2) 142835 Telex: 856-78216	SWEDEN AMERIKANSKA TELEPRODUK- TER AB Box 66 Jagerhorns vag 10 S-127 22 Skarholmen Telephone: (8) 7100620 Telex: 854-8135089 Fax: (8) 7109960
AUSTRIA WILTRON GmbH Rudolf Diesel Str 17 8031 Gilching, West Germany Telephone: (49) 8105- 8535/8055/8056 Telex: 841-528523 Fax: (49) 8105-1700	WEST GERMANY WILTRON GmbH Rudolf Diesel Str 17, 8031 Gilching Tel: (8105) 8055/8535/8056 Telex: 841-528523 Fax: (8105) 1700	ITALY ELETTRONUCLEONICA, S.P.A. Piazza de Angeli 7, 20146 Milano Telephone: (2) 4982451 Twx: 843-332033	PAKISTAN SUPERIOR ELECTRONICS AS- SOCIATED B-98 Block H North Nasimabad, Karachi 33 Telephone: (21) 613655 Cable: SEACONSULT Karachi	SWITZERLAND AMOTEC ELECTRONIC AG Buehlstr. 1 / P.O. Box 45 CH-8125 Zollikonberg Telephone: (1) 3915901 Telex: 845-816906 Fax: (1) 391-56-33
BELGIUM HEYNEN N.V. Bedrijfsstraat 2 B-3500 Hasselt Telephone: 32-11-210006 Telex: 846-39047 Fax: 11211812	HONG KONG SCHMIDT & CO (H.K.) LTD. 18th Floor, Great Eagle Centre 23 Harbour Road, Wanchai Telephone: (5) 8330222 Telex: 780-74766 Fax: (5) 8918754	ELETTRONUCLEONICA Viale Erminio Spalla 41, 00142 Rome Telephone: (06) 5042485 Telex: 843-614128	PERU IMPORTACIONES & REPRESENTACIONES ELECTRONICAS S.A. Avda. Franklin D. Roosevelt 105 (Edificio Rimac) Lima 1 Telephone: (14) 272076 Telex: 394-25663 Cable: IREING	TAIWAN HITRON TECHNOLOGY, INC. 6F-1, 344 Ming Sheng E. Road Taipei, Taiwan 104 Telephone: (2) 5039916 Telex: 785-10199 Fax: (2) 5057427
BRAZIL TECELMCO TECNOLOGIA ELETRONICA LTDA. Rua Major Sertorio, 463 - 4 Andar 01222 Sao Paulo Telephone: 55-11- 2573645/2584286 Telex: 391-01125588 PYRO BR	INDIA HINDITRON SERV. PVT. LTD. Eros Bldg., 5th Floor Maharishi Karve Road, Churchgate Bombay 400 020 Tel: (22) 8125344/8121316/- 8121615/8221529 Telex: 953-1175326/1173448	JAPAN WILTRON K.K. 5 Chome, 29-20, Shiba, Mita Bldg. 6F, Minato-ku Tokyo 108 Tel: (03) 7980411 Fax: (03) 798-0419 WILTRON K.K. Telephone: (045) 316-0381 R Fax: (045) 316-0380, Yokohama	PHILIPPINES PHILIPPINE ELECTRONIC IN- DUSTRIES, INC. P.O. Box 498 Makati Commercial Center Makati, Metro Manila Telephone: (2) 879926 Telex: 742-22036	THAILAND DYNAMIC SUPPLY ENGINEER- ING R.O.P. 12 SOI Pasana, Ekamai Sukhumvit 63, BKK 10110 Telephone: (2) 914434 Telex: 788-82455 Fax: (2) 3811467
CANADA WILTRON INSTRUMENTS LTD. 215 Stafford Road, Unit 102 Nepean, Ontario K2H 9C1 Telephone: (613) 726- 8800/8801/8802 Fax: (613) 820-9525	HINDITRON SERV. PVT. LTD. Field Service Centre 15 Community Centre Panchshilla Park New Delhi 110 017 Telephone: 653397 Telex: 0314890	KOREA MYOUNG CORPORATION C.P.O. Box 8892, Seoul Telephone: (02) 784-9942 Telex: 787-24283 Fax: (822) 784-2387	PORTUGAL DECADA ESPECTRAL-EQUI- PAMENTOS DE ELECTRONICA E CIENTIFICOS, SARL Av. Bombeiros Voluntarios, Lote 102B Miraflores/Alges, 1495 Lisboa Tel: (01) 410-3420/6073/6098 Telex: 832-15515 Fax: 35114101844	TURKEY TEST MUHENDISLIK VE MUSAVIRLIK TICARET LIMITED SIRKETI Sehit Adem Yavuz Sokak No. 6/17 Kizilay, Ankara Telephone: (41) 18-05-98 Telex: 821-46147
CHINA CHINA NATIONAL INSTRU- MENTS IMPORT & EXPORT CORPORATION P.O. Box 2811 Xi Jiao, Er-Li Kou Beijing Telephone: 890931 Telex: 716-22304 CMIEC CN	HINDITRON SERVICES PVT. LTD. Srinath Complex, 5th Floor 1-1-58/1 to 1-1-58/11 Sarojini Devi Road Secunderabad 500 003 Telephone: (city code) 821117 Telex: 0155575 NIMA IN	KUWAIT TAREQ COMPANY P.O. Box Safat 20506, 13066 SAFAT Telephone: 436100/436045 Telex: 959-22315 KT Fax: 965-2436100, 2436045	QATAR TRADING AND AGENCY SERV. P.O. Box 1884, Doha Telex: 957-4325 TRAGS DH Fax: 974-422255	UNITED ARAB EMIRATES SALEM HILAL TRABISH AL MAN- SOURI ENTERPRISES P.O. Box 6868, Abu Dhabi Telephone: (2) 331200 Telex: 949-23649
CHINA ELECTRONICS IMPORT & EXPORT CORPORATION 49 Fuxing Road, Beijing Telephone: 81-2687/3972 Telex: 716-22475 CEIEC CN	HINDITRON SERVICES PVT. LTD. Office No. 6 Shantiniketan, 6th Floor 8 Curmac Street, Calcutta Telephone: (33) 434032/477541 Telex: 021-4153 HCPL IN Cable: FLUKHIND-Calcutta	LUXEMBOURG HEYNEN N.V. Bedrijfsstraat 2 B-3500 Hasselt, Belgium Telephone: 8851-96111 Telex: 846-39047 Fax: 11211812	SAUDI ARABIA ELECTRONIC EQUIPMENT MARKETING CO. P.O. Box 3750, Riyadh, 11481 Telephone: (1) 4771650 Telex: 928-201120 Fax: 96614785140, 4783662	UNITED KINGDOM WILTRON LTD. Wiltron House, Pinehill Road Crowthorne, Berkshire RG1 1 7JD England Telephone: (344) 777778 Telex: 851-847913 Fax: (0344) 761783
COSTA RICA ELECTRO-IMPEX, S.A. Apartado 620, San Jose Telephone: 215954 Telex: 303-2645 ELEPEX	MALAYSIA MECOMB MALAYSIA SDN BHD Lot 20, Jalan 225 46100 Petaling Jaya, Selangor Telephone: (03) 743422 Telex: 784-37764 Fax: (03) 7743414	MEXICO MEXITEK, S.A. Eugenia 408 Deptos. 2 y 3 Col. Del Valle, Deleg. B. Juarez Apdo. Postal 12-1012 03100 Mexico, D.F. Telephone: (5) 360910 Telex: 383-1773239 MEXIME	SINGAPORE SINGAPORE ELECTRONIC & ENGINEERING (PRIVATE), LTD. 24 Ang Mo Kio Street 65 Industrial Park 3 Singapore 2056 Telephone: 4593555 Telex: 786-21901 Fax: 4553613	YUGOSLAVIA SOUR INDUSTRIAIMPORT Blatine 12-14, 58000 Split Telephone: (58) 510888 Telex: 862-26335
DENMARK S C METRIC A/S Skodsborgvej 305 DK-2850 Naerum Telephone: (2) 804200 Telex: 855-37163	MEXICO HINDITRON SERV. PVT. LTD. 33/44A Rajmahal Villas Extn. Bangalore 560 006 Telephone: (city code) 33139 Telex: 845-741	NETHERLANDS Heynen B.V. P.O. Box 10, 6590 AA Gennep Telephone: (8851) 96111 Telex: 844-37282	SOUTH AFRICA PNI ELECTRONICS P.O. Box 39127, Bramley 2018 Tel: (1) 7863170/7863171- 7863172 Telex: 4-24409 SA Fax: (11) 786-1807	
EGYPT ALKAN ESTABLISHMENT 2 El Mesaha Square, Dokki, A.R.E. P.O. Box 1913, Cairo 11511 Telephone: (2) 987114 Telex: 927-93644 ALKAN UN & 92096 EKA UN	INDONESIA PT CENTRONIX 36, Jalan Matraman Raya Jakarta Timur Telephone: (21) 884087 Telex: 796-48216			

SECTION III LOCAL OPERATION

CONTENTS

Pararaph	Title	Page
3-1	INTRODUCTION	3-3
3-2	CONTROL PANEL CONTROLS	3-3
3-2.1	CRT Display	3-3
3-2.2	SYSTEM FUNCTION Keys	3-4
3-2.3	DISPLAY Keys and Indicator	3-5
3-2.4	DATA ENTRY Keys and Knob	3-9
3-2.5	HARD COPY Keys	3-9
3-2.6	ENHANCEMENT Keys and Indicators	3-12
3-2.7	GPIB Indicator and Key	3-13
3-3	REAR PANEL CONNECTORS	3-14
3-4	MEASUREMENTS WITH THE 561 SCALAR NETWORK ANALYZER	3-14
3-4.1	Transmission and Return Loss Measurements	3-14
3-4.2	Absolute Power Measurement	3-14
3-4.3	Alternate Setup Measurements	3-14
3-5	OPERATIONAL CHECKOUT	3-14
3-6	ERROR MESSAGES	3-14
3-7	561 ANALYZER CONNECTIONS TO WILTRON SWEEP GENERATORS	3-14

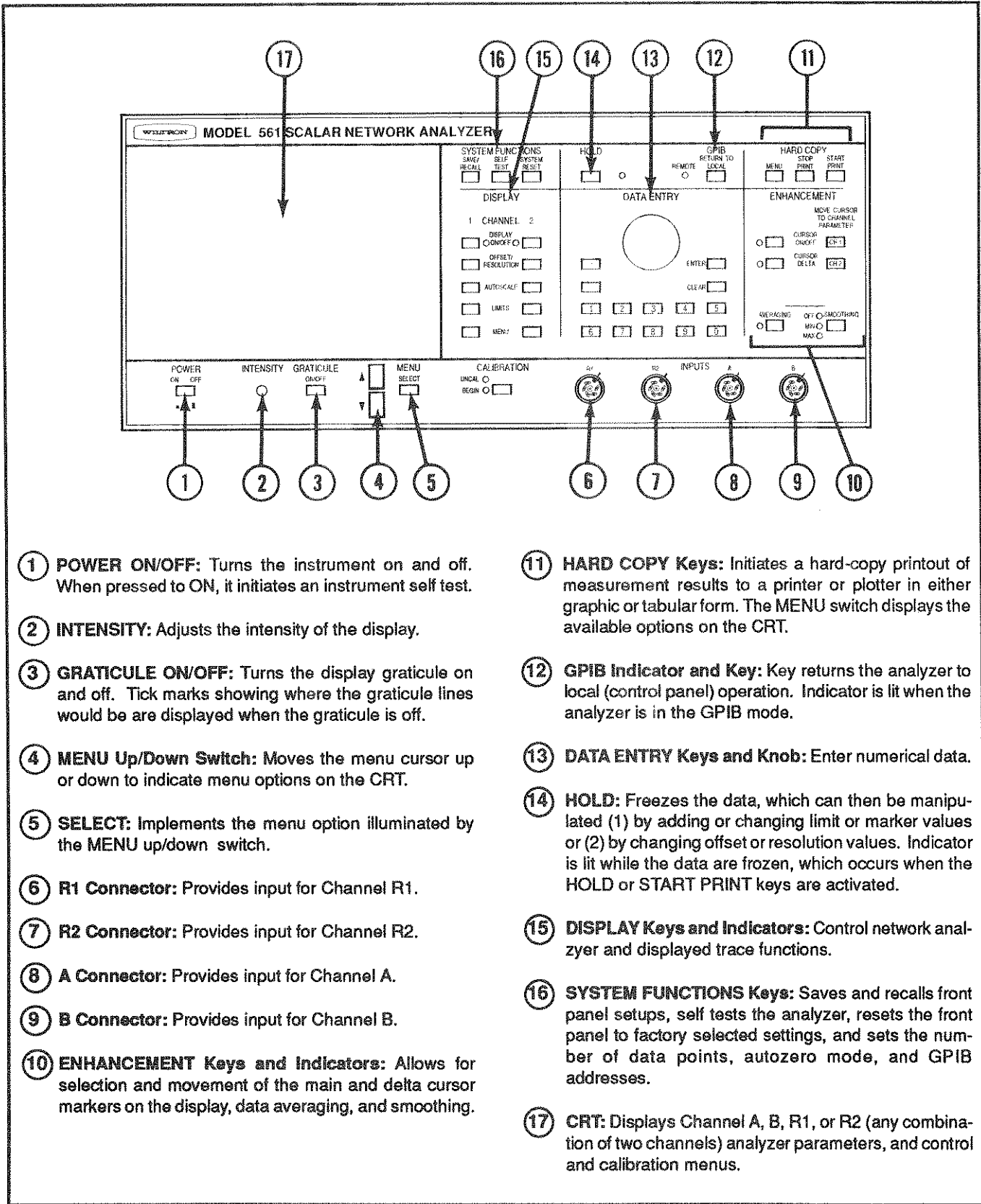

- ① **POWER ON/OFF:** Turns the instrument on and off. When pressed to ON, it initiates an instrument self test.
- ② **INTENSITY:** Adjusts the intensity of the display.
- ③ **GRATICULE ON/OFF:** Turns the display graticule on and off. Tick marks showing where the graticule lines would be are displayed when the graticule is off.
- ④ **MENU Up/Down Switch:** Moves the menu cursor up or down to indicate menu options on the CRT.
- ⑤ **SELECT:** Implements the menu option illuminated by the MENU up/down switch.
- ⑥ **R1 Connector:** Provides input for Channel R1.
- ⑦ **R2 Connector:** Provides input for Channel R2.
- ⑧ **A Connector:** Provides input for Channel A.
- ⑨ **B Connector:** Provides input for Channel B.
- ⑩ **ENHANCEMENT Keys and Indicators:** Allows for selection and movement of the main and delta cursor markers on the display, data averaging, and smoothing.

- ⑪ **HARD COPY Keys:** Initiates a hard-copy printout of measurement results to a printer or plotter in either graphic or tabular form. The MENU switch displays the available options on the CRT.
- ⑫ **GPIB Indicator and Key:** Key returns the analyzer to local (control panel) operation. Indicator is lit when the analyzer is in the GPIB mode.
- ⑬ **DATA ENTRY Keys and Knob:** Enter numerical data.
- ⑭ **HOLD:** Freezes the data, which can then be manipulated (1) by adding or changing limit or marker values or (2) by changing offset or resolution values. Indicator is lit while the data are frozen, which occurs when the HOLD or START PRINT keys are activated.
- ⑮ **DISPLAY Keys and Indicators:** Control network analyzer and displayed trace functions.
- ⑯ **SYSTEM FUNCTIONS Keys:** Saves and recalls front panel setups, self tests the analyzer, resets the front panel to factory selected settings, and sets the number of data points, autozero mode, and GPIB addresses.
- ⑰ **CRT:** Displays Channel A, B, R1, or R2 (any combination of two channels) analyzer parameters, and control and calibration menus.

Figure 3-1. Model 561 Scalar Network Analyzer Front Panel Controls

SECTION III LOCAL (CONTROL PANEL) OPERATION

3-1 INTRODUCTION

This section describes the operation of the 561 Scalar Network Analyzer using the control panel controls. It describes the controls and rear panel connectors; how to make transmission, return loss, power, and alternating setup measurements; and how to check that the instrument is operating properly.

3-2 CONTROL PANEL CONTROLS

Operation of the control panel controls is described in Figure 3-1 and in paragraphs 3-2.1 thru 3-2.7

3-2.1 CRT Display (Figure 3-2)

The CRT displays the measurement traces, the present settings for the 561, cursors, markers, limit lines, menu options, and the frequency source parameters.

a. CRT Screen

Displays either (1) the respective outputs of input A, B, R1, or R2 on traces 1 and 2, (2) the single input from either A, B, R1, or R2 signal on trace 1 alternating with trace 2, or (3) the Channel A signal on trace 1 alternating with the Channel B signal on trace 2 or other combinations.

b. NETWORK ANALYZER Settings

The two lines labeled "1" and "2" across the top of the screen display the type of measurement selected and the offset and vertical resolution values set for traces 1 and/or 2.

c. SOURCE Information

Source information is displayed in the box in the top right side of the screen. This box displays the source model number, or "ALTERNATE SETUP" when an alternating setup has been selected, or "HOLD" when the instrument is in the HOLD mode.

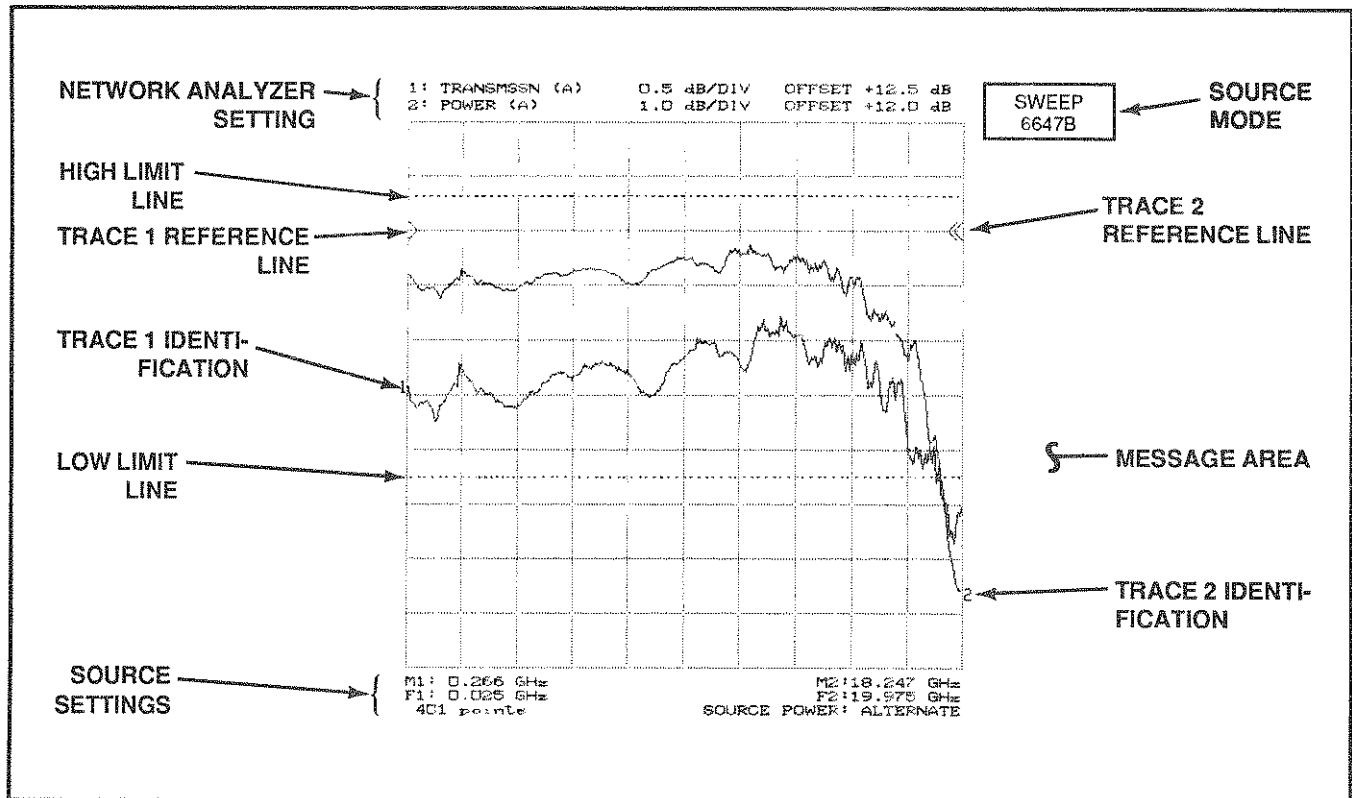

Figure 3-2. CRT Display

d. SOURCE Frequency and Power and Horizontal Resolution (GRATICULE) Settings

The three lines along the bottom of the screen display (1) the source start/stop frequencies; (2) the alternate setup start/stop frequencies (see Table 3-3); (3) the RF power setting and horizontal resolution (GRATICULE) of the displayed traces; and (4) the power sweep values, where appropriate.

In the normal-sweep mode, the horizontal resolution and intelligent-graticule divisions are automatically chosen for optimum display of the selected frequency-sweep width. In either of the two alternate-setup modes, the graticule is fixed at 10 vertical and 10 horizontal divisions.

3-2.2 SYSTEM FUNCTION Keys (Figure 3-3)

The SYSTEM FUNCTION keys are described in subparagraph a through c.

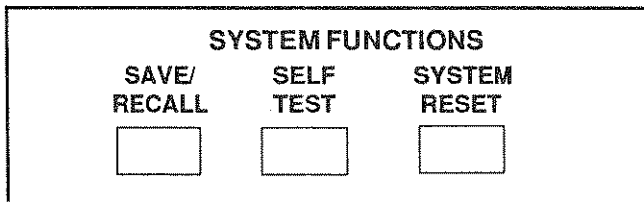

Figure 3-3. SYSTEM FUNCTION Keys

a. SAVE/RECALL Key

Displays a menu (Figure 3-4) that lets the operator SAVE the current control panel setting into memory locations 1-9 and the setup plus calibration into memory locations 1-4, RECALL any of nine stored front panel setups and or calibration, or PREVIEW any of the nine stored setups. The MENU UP/DOWN switch (Figure 3-1) in conjunction with the MENU SELECT switch, is used to make the selection. Should this key be pressed and then not wanted, the DATA ENTRY CLEAR (Figure 3-11) key can be used to cancel the key action.

b. SELF TEST Key

Initiates a self test of the analyzer. If the analyzer functions properly, the screen displays "ALL TESTS PASSED." If the self test reveals a problem, the screen displays a failure message.

c. SYSTEM RESET Key

Displays a menu (Figure 3-5) that lets the operator use the MENU SELECT key (Figure 3-1) to either restore the factory-selected control panel settings; select the number of frequency data points; set the GPIB addresses of the 561, sweeper, or plotter; or select either RF ON or RF OFF (during retrace) according to the sweeper used. If on the dedicated bus and the 6600B is used, the 561 automatically configures the 6600B RF retrace for correct 561 autozeroing.

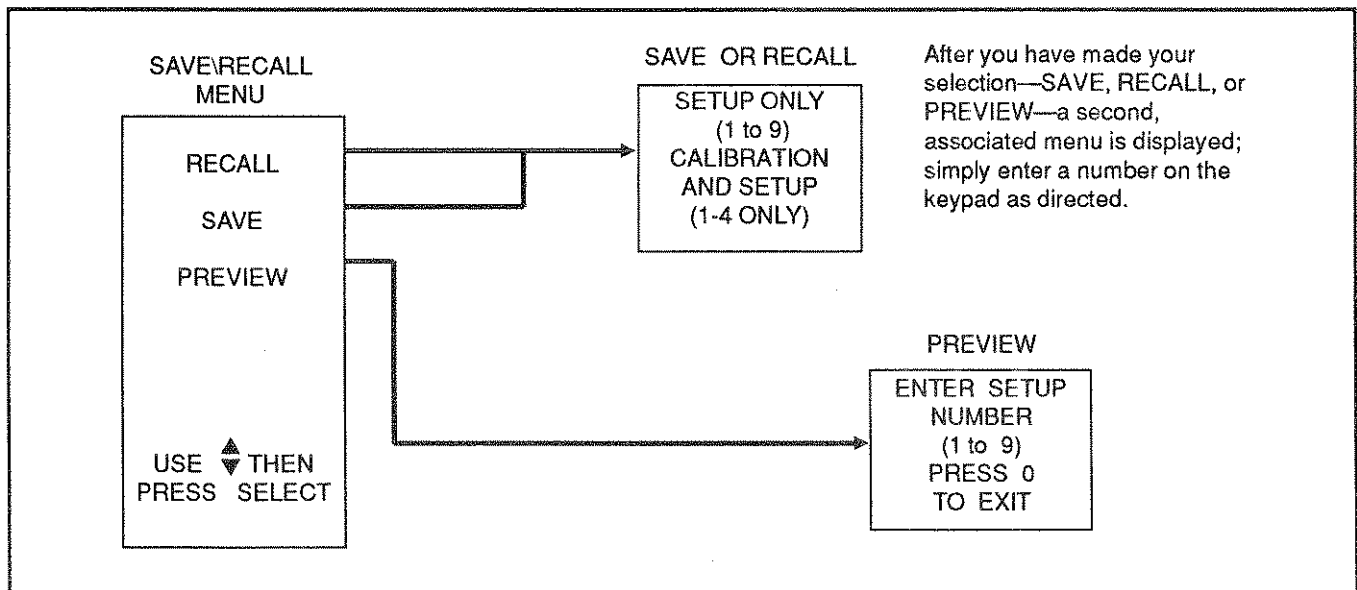

Figure 3-4. SAVE/RECALL Key Menus

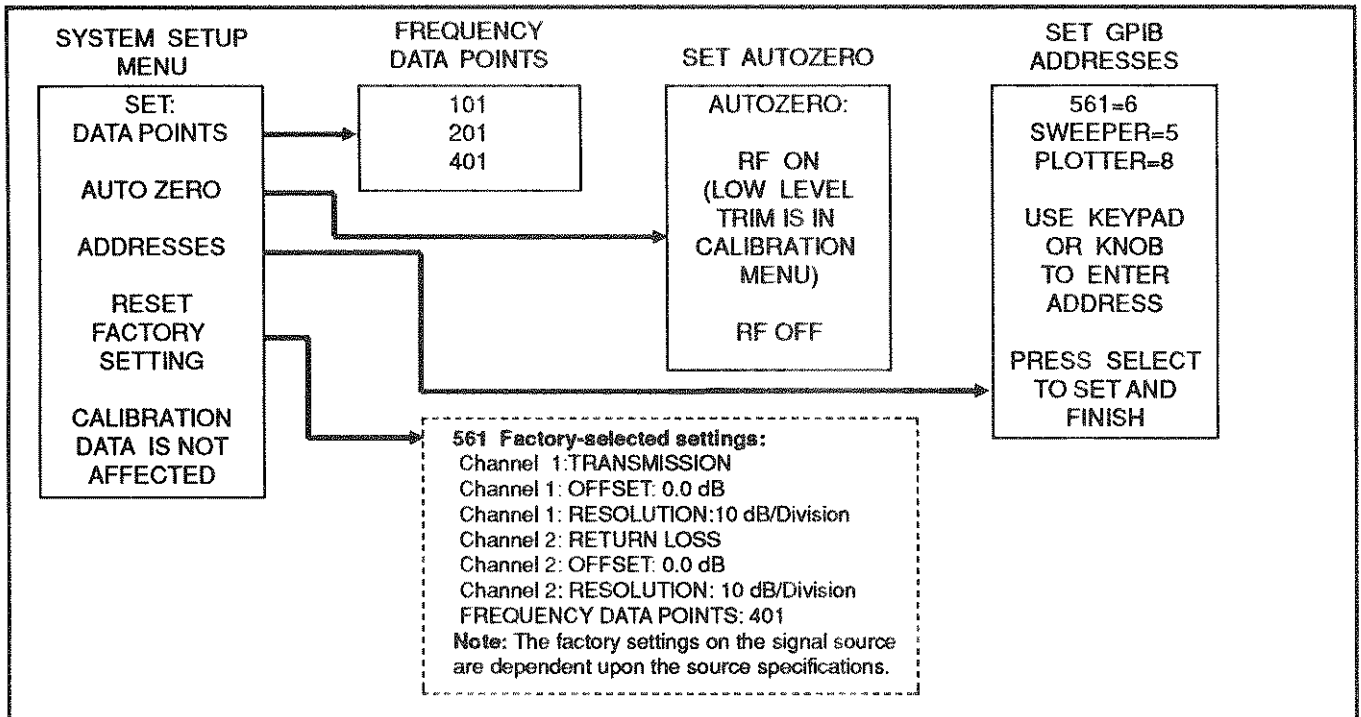

Figure 3-5. SYSTEM RESET Menu and Factory-selected Settings

3-2.3 DISPLAY Keys and Indicator (Figure 3-6)

The DISPLAY keys and indicator described below are the same for both channels. Generally, with the exception of DISPLAY ON/OFF and AUTOSCALE, should one of these keys be pressed and then not

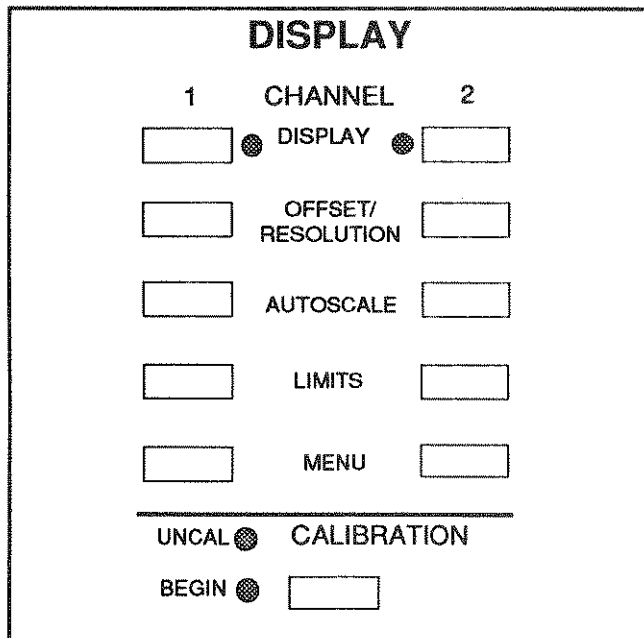

Figure 3-6. DISPLAY Keys and Indicators

wanted, the CLEAR (Figure 3-11) key can be used to cancel the key action.

a. DISPLAY ON/OFF Key and Indicator

Key turns its associated trace and reference line indicator on or off (Figure 3-2). The associated indicator is lit when the trace is on.

b. MENU Key

Displays a menu (Figure 3-7) that lets the operator select the measurement type (transmission, return loss, or power), view the calibration, select the input, or move the reference line.

c. AUTOSCALE Key

Sets the associated trace at optimum offset and resolution values for viewing the measured data.

d. OFFSET/RESOLUTION Key

Displays a menu (Figure 3-8) that lets the operator select OFFSET and RESOLUTION.

e. LIMITS Keys

Allows the operator to use two horizontal limit lines that may be used to establish go/no-go data limits (Figure 3-9). Limit lines may be either horizontal or complex. Complex limits allow for setting up to ten different values for both the upper and lower limit lines.

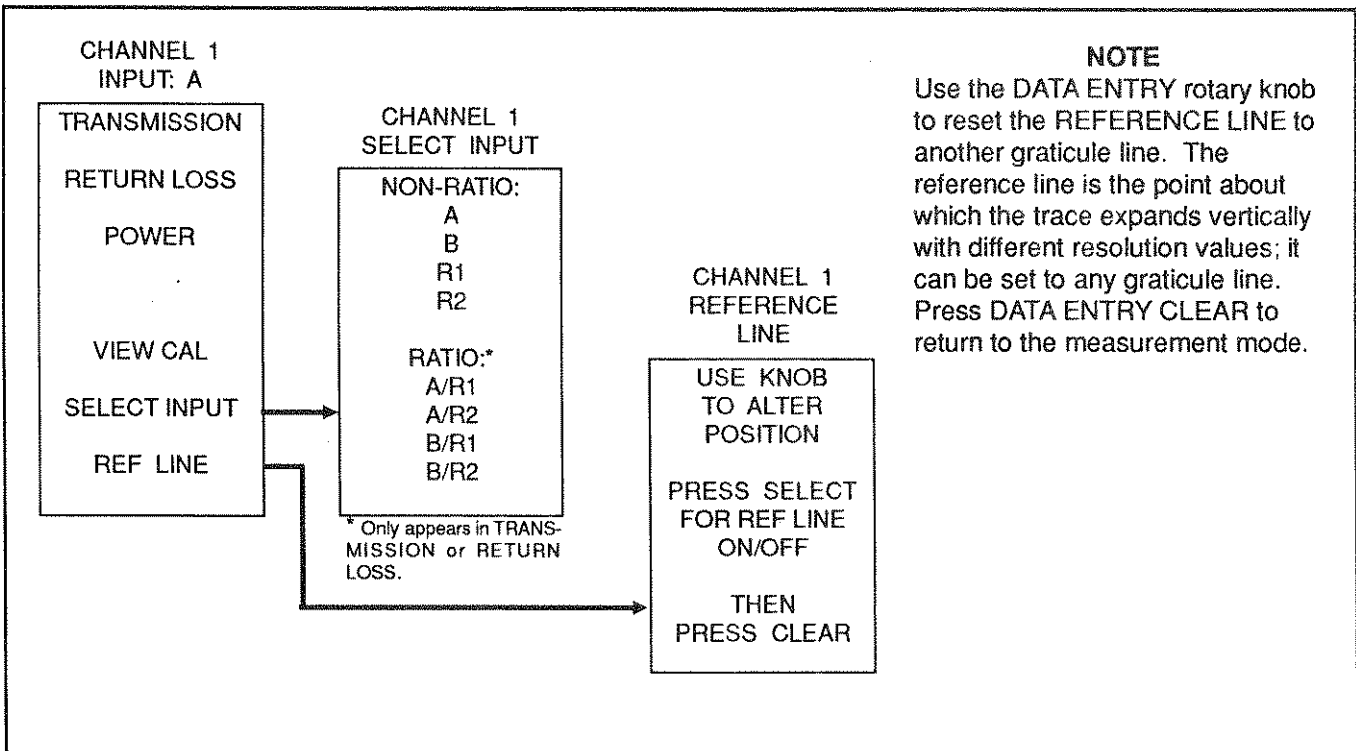

Figure 3-7. DISPLAY MENU Key Menu

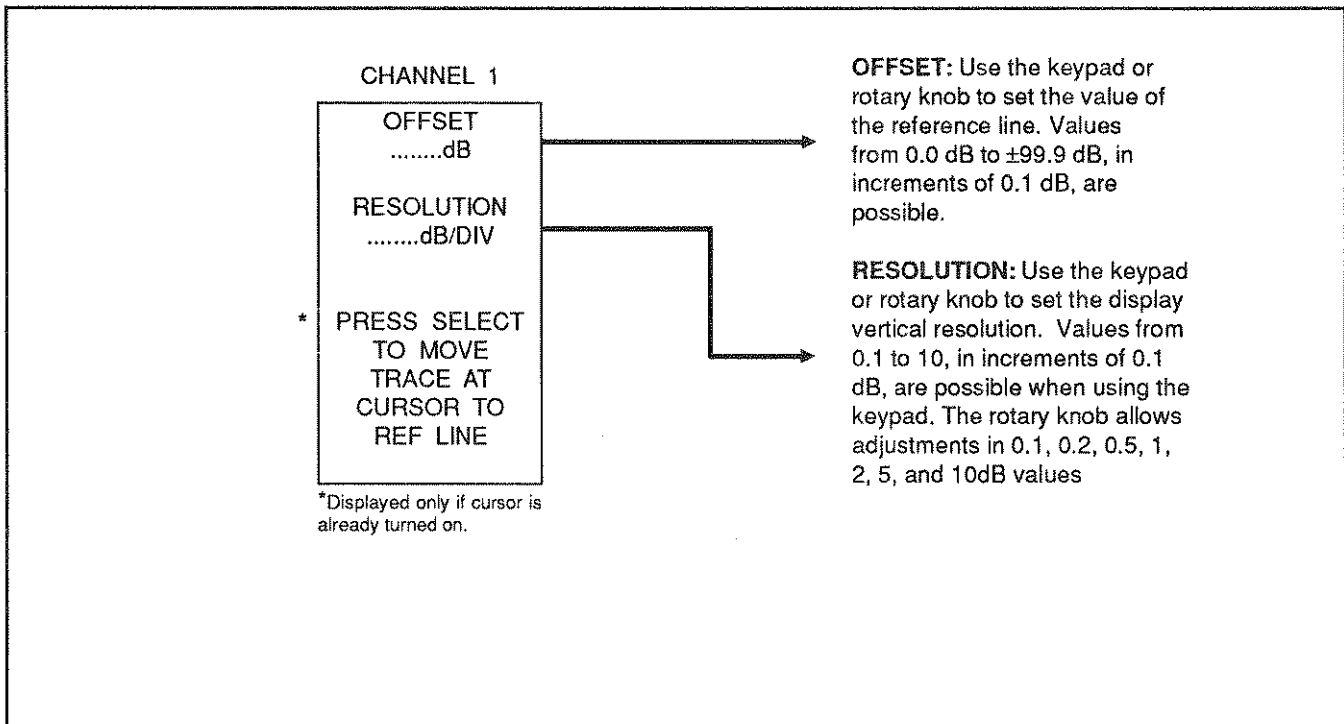

Figure 3-8. OFFSET/RESOLUTION Key Menu

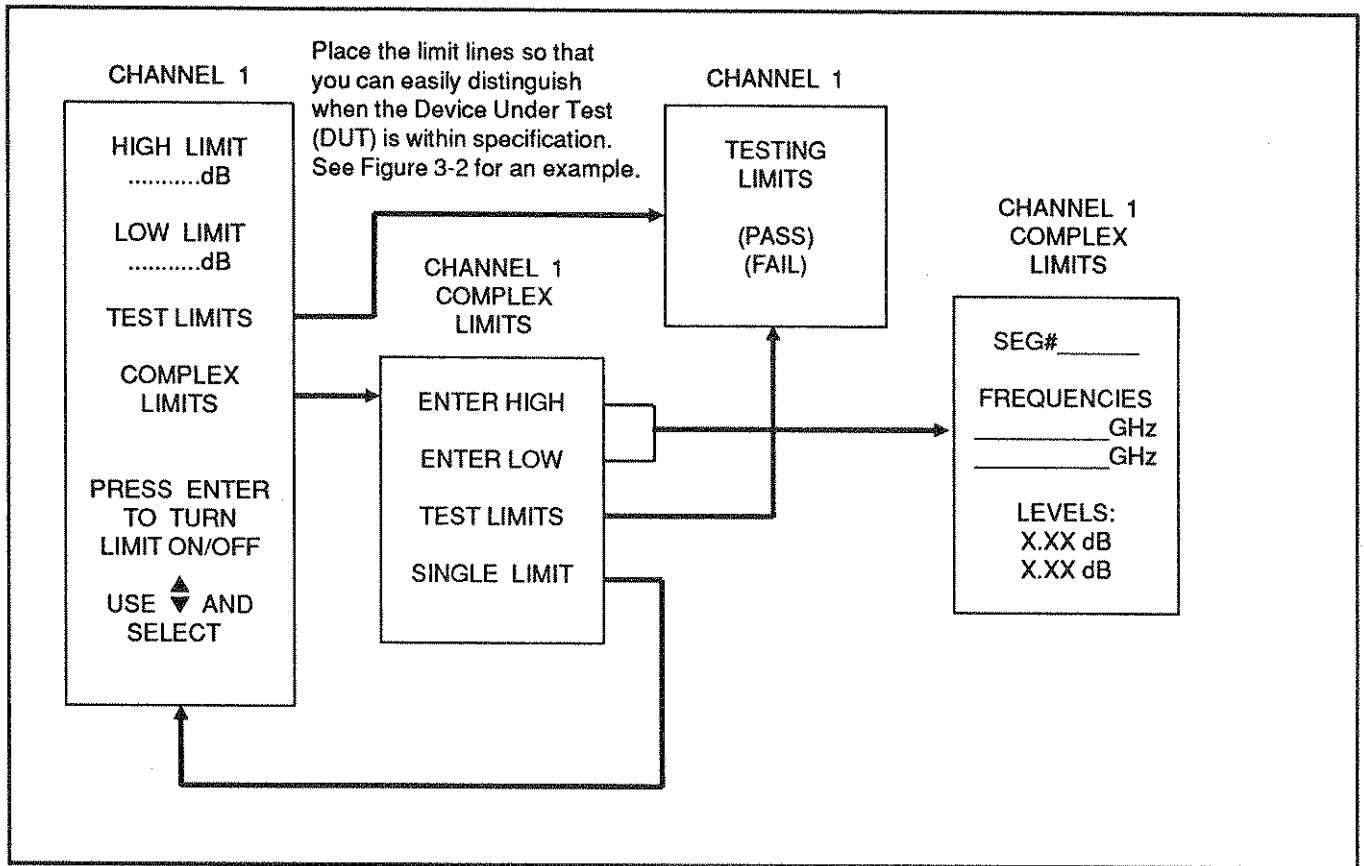

Figure 3-9. LIMITS Key Menu

CALIBRATION is the process whereby losses inherent in a transmission or return loss measurement system are measured, stored in internal memory, and later subtracted so that the results displayed are those of the test device, minus residual losses. Pressing the CALIBRATION key initiates the following sequence of menus when the Channel 1 trace has been selected to display transmission loss or gain and the Channel 2 trace return loss.
Important: Set output power for the desired level before beginning the calibration sequence.

Refer to Figure 3-22 (page 3-16) for the following test setup.

Connect the RF Input port on the SWR Autotester to the RF OUTPUT port on the sweep generator. An adapter may be needed. Connect the RF detector between input A of the Network Analyzer and the Test Port on the SWR Autotester.

When only transmission loss is being measured and the SWR Autotester is not being used, the test port called out in the menu is the port to which the test device connects. In most cases, it will be the RF OUTPUT port on the sweep generator.

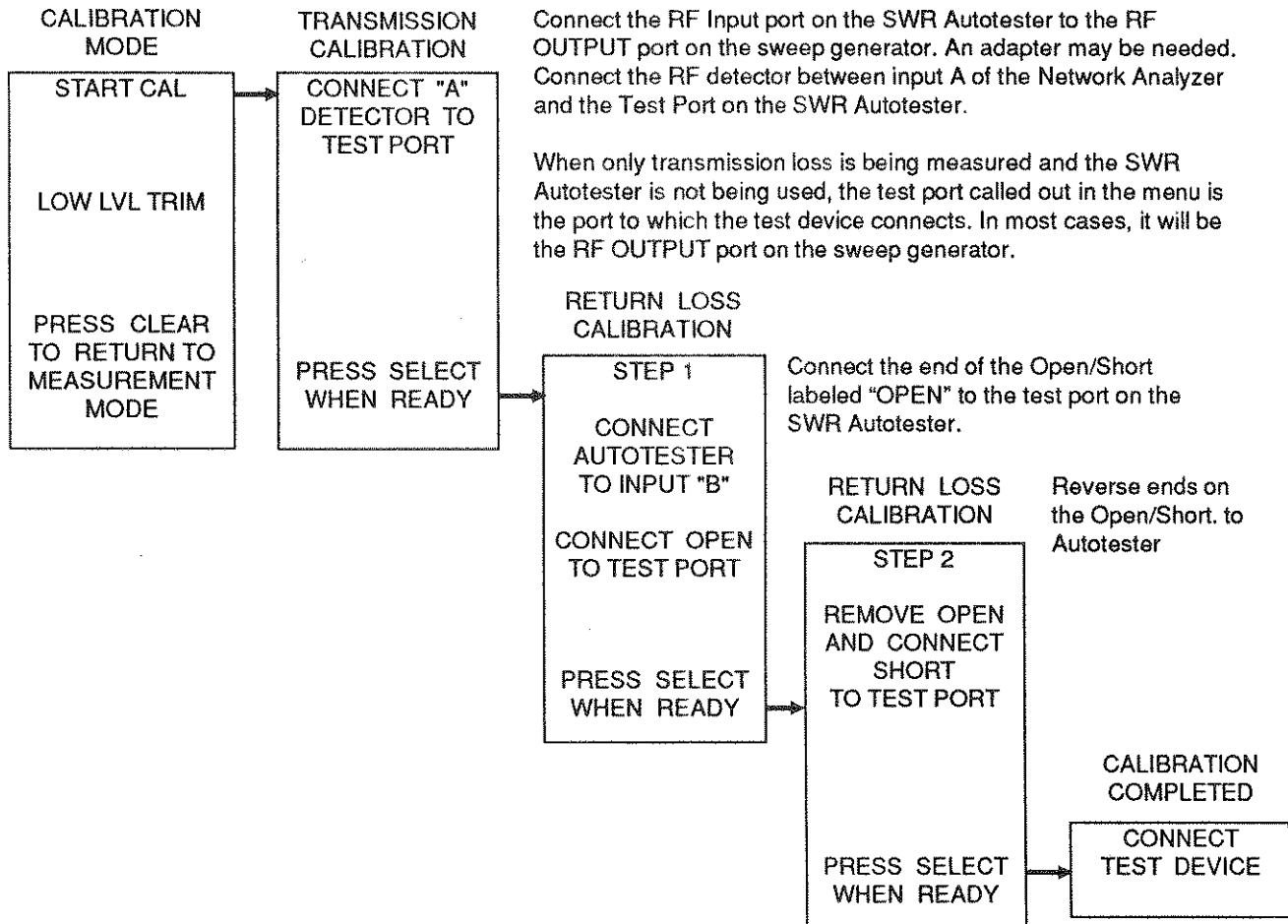

When the calibration cycle is complete, the losses inherent in the SWR Autotester, Adapter, and RF detector have been measured and stored. In all future measurements (in this configuration) of test devices *at this level of* output power, these losses will be subtracted from measured losses; consequently, the results displayed will be those of the test device minus residuals.

Figure 3-10. CALIBRATION Key Menu Sequence

- f. **CALIBRATION Key**
Displays a series of instructions (Figure 3-10 on facing page) that guide the operator through the calibration cycle. The calibration sequence is determined by the measurements chosen.
- g. **UNCAL Indicator**
Lights when either measurement trace is uncalibrated.
- h. **BEGIN Indicator**
Lights at the beginning of the calibration cycle and remains lit until the cycle is completed.

- a. **Knob**
Enters variably adjusted measurement values (e.g. cursor position, offset, resolution, etc.)
- b. **Keypad**
Enters discrete measurement values.
- c. **ENTER Key**
Terminates data entries made from the keypad.
- d. **CLEAR Key**
Clears entered value, if pressed before the ENTRY key, and clears a displayed menu.

3-2.4 DATA ENTRY Keys and Knob (Figure 3-11)

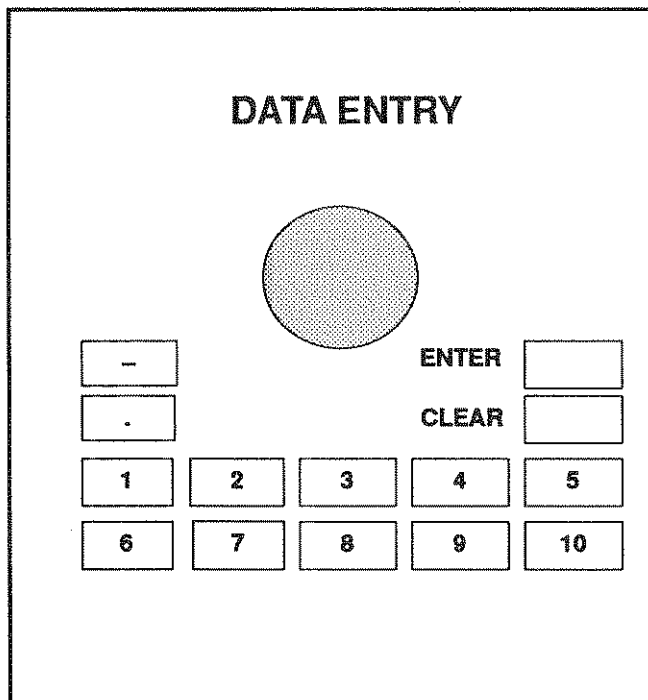

Figure 3-11. DATA ENTRY Keys and Knob

The DATA ENTRY keys and knob are described in subparagraphs a through d.

3-2.5 HARD COPY Keys (Figure 3-12)

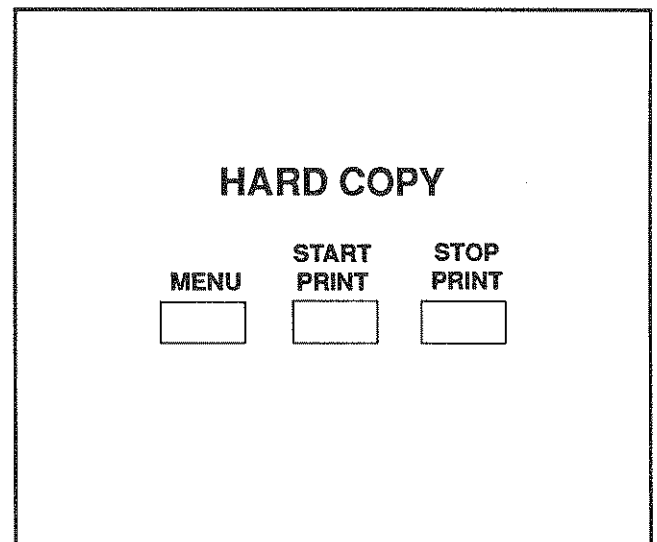

Figure 3-12. HARD COPY Keys

The HARD COPY keys are described in subparagraphs a through c.

- a. **MENU Key**
Displays a menu (Figure 3-13) that lets the operator select between printing either the graphic display or a tabulation of the measured values to a printer, or the graphic values to a plotter.

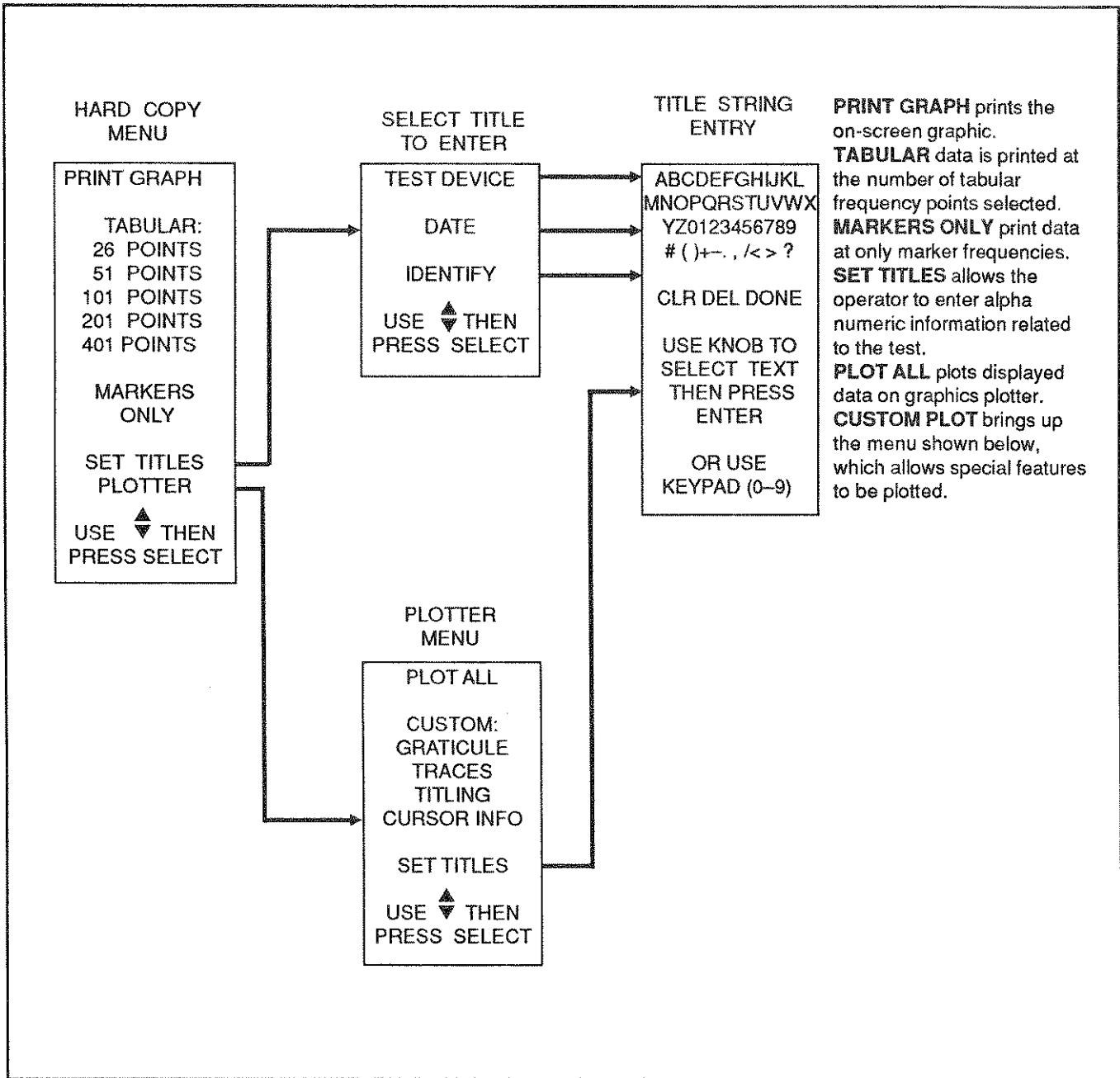

Figure 3-13. HARD COPY Menu

b. START PRINT Key

Freezes the displayed data and starts printing it. The type of printout then obtained, graphic or tabulated, is based on the last DISPLAY MENU key item selected. (The printing may also be started by the MENU SELECT switch if the HARD COPY menu is displayed.)

c. STOP PRINT Key

Stops printing the data immediately. In the case of plotting, the end of a data string is finished and the plotter left in a reset state.

Examples of hard copy printouts are shown in Figure 3-14.

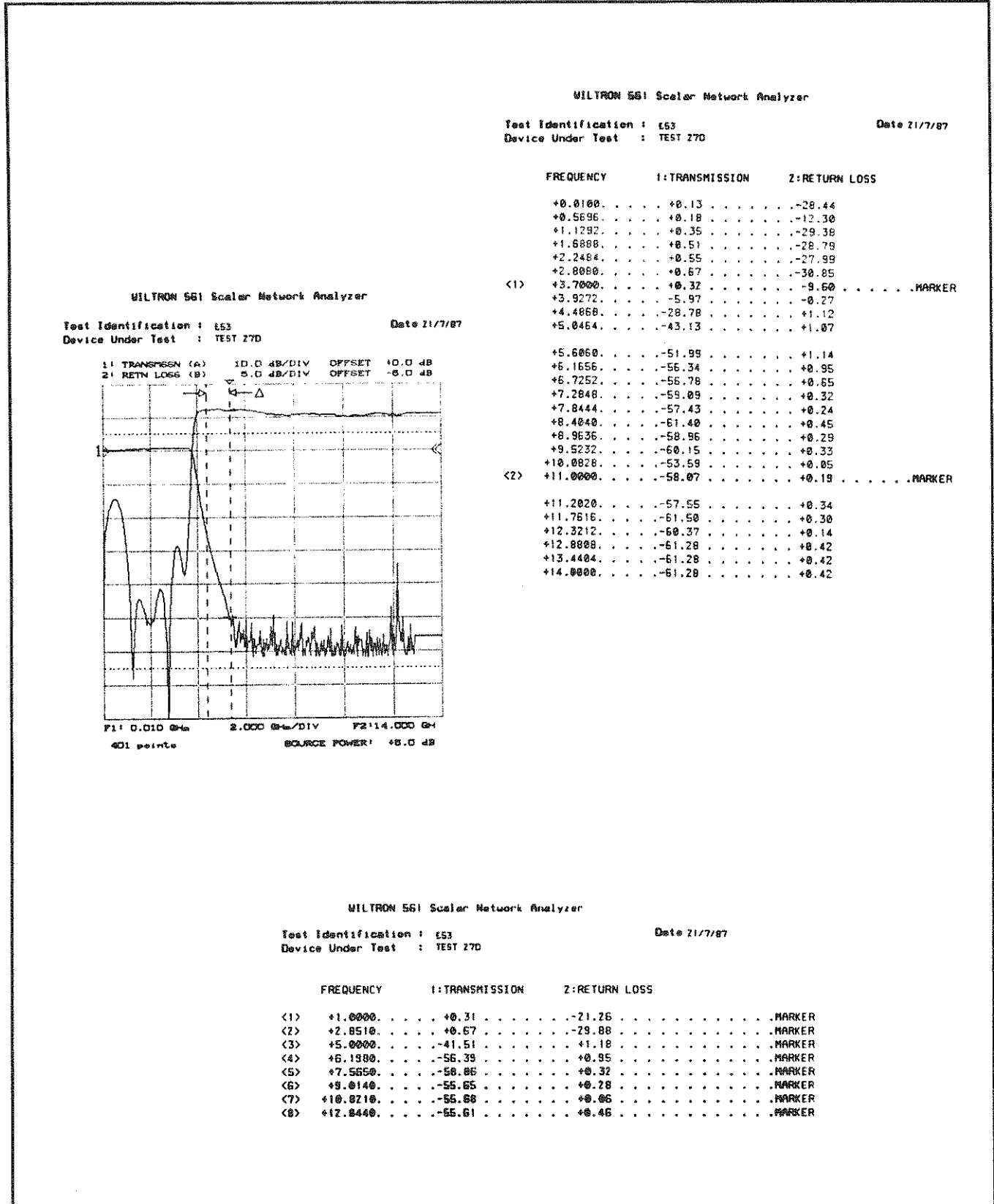

Figure 3-14. Hard Copy Examples

3-2.6 ENHANCEMENT Keys and Indicators (Figure 3-15)

The ENHANCEMENT keys and indicators are described below.

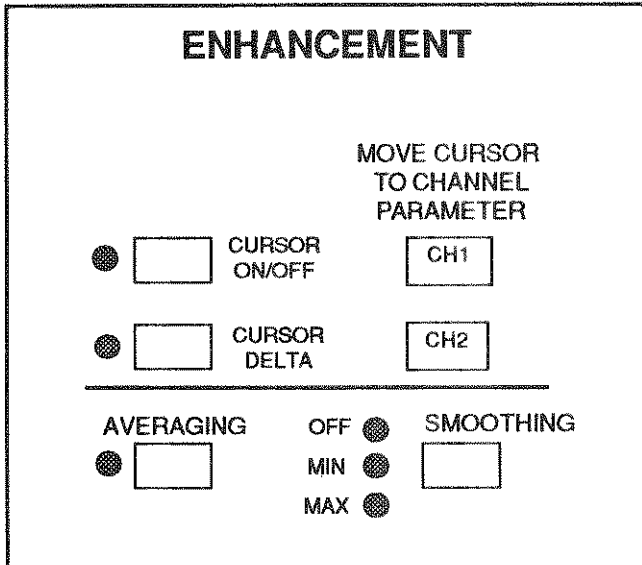

Figure 3-15. ENHANCEMENT Keys and Indicators

a. CURSOR ON/OFF Key

Positions the main cursor to the frequency point it was at when the function was last exited. Thereafter, it is continuously variable with the tuning knob, or it may be positioned at the next marker by pressing the ENTER switch. The frequency and amplitude of the test data at the cursor on both traces are digitally displayed.

b. CURSOR DELTA Key

Positions a reference cursor on the screen. The main cursor will then move as the tuning knob is varied, or it will advance to the next marker if the ENTER switch is pressed. To establish a new reference, the main and reference positions may be reversed by enabling the MENU SELECT switch. The difference in amplitude and frequency between the reference cursor and the main cursor positions on the test data are displayed for both traces.

c. MOVE CURSOR TO CHANNEL PARAMETER Key (Figures 3-16 and 3-17)

Pressing this key brings up a menu that lets you move the cursor quickly to any one of the following points on the screen:

- The minimum or maximum value of test data on either trace (depending upon whether CH1 or CH2 was selected).
- The amplitude on either trace to the left or right of the main cursor position at the frequencies where the test data are equal to the entered value of X dB or dBm.
- Above and below the present main cursor position at the frequencies where the test data are equal to the entered value "X" dB (CURSOR DELTA off), or the "delta" dB (CURSOR DELTA on).
- The next highest frequency marker.
- The frequency of the active marker.

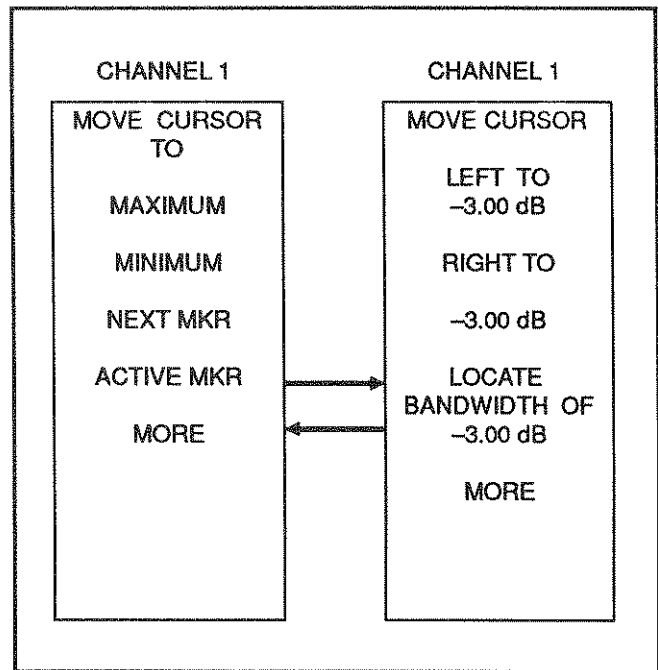

Figure 3-16. MOVE CURSOR TO CHANNEL PARAMETER Menus (with Δ off)

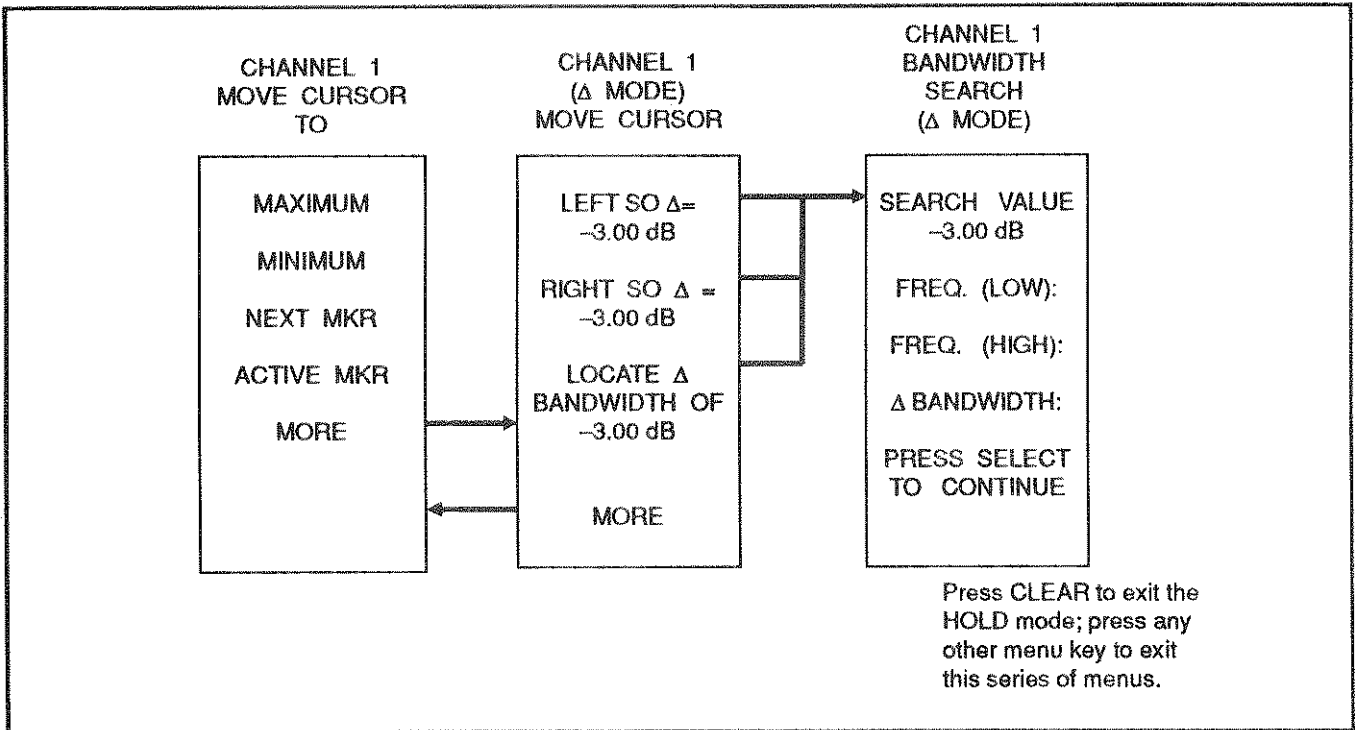

Figure 3-17. MOVE CURSOR TO CHANNEL PARAMETERS Menu (with Δ on)

- d. **SMOOTHING Key and Indicator**
Key provides two levels of filtering, MIN and MAX, that improve the display at low-signal levels. The OFF indicator lights when no smoothing (low-level filtering) is supplied.
- e. **AVERAGING Key and Indicator**
When you select averaging, 4 to 256 successive sweeps can be averaged to smooth the trace display. The AVERAGING Menu is shown in Figure 3-18.

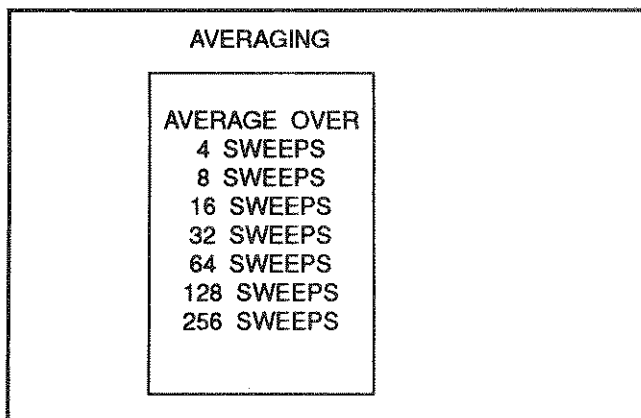

Figure 3-18. AVERAGING Menu

3-2.7 GPIB Indicator and Key (Figure 3-19)

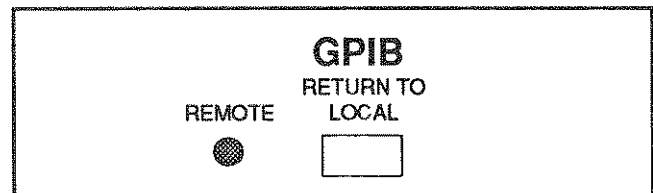

Figure 3-19. GPIB Indicator and Key

- a. **REMOTE Indicator**
Lights when in the remote (GPIB) mode. When lit, a menu providing GPIB status (Figure 3-20).
- b. **RETURN TO LOCAL Key**
If pressed while in the GPIB mode, the analyzer returns to the local mode. This occurs unless the local lockout (LLO) message has been programmed, in which case the key causes no action. If pressed while in the local mode, the analyzer's GPIB address displays in the MENU area of the screen.

Associated indicator lights when analyzers respectively talking, listening, generating an SRQ, or is in the local lockout or remote mode.

GPIB
STATUS

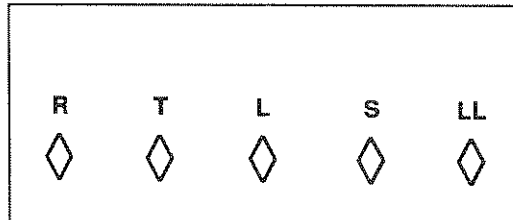

Figure 3-20. GPIB Status Display

3-3 REAR PANEL CONNECTORS

The rear panel contains multipin GPIB and printer connectors, the GPIB address switches, the line voltage module, and additional input/output connections. The line voltage module and GPIB connector and address switches are described in Section II; the printer interface and the additional input/output connections are described in Figure 3-21.

3-4 MEASUREMENTS WITH THE 561 SCALAR NETWORK ANALYZER

The 561 Scalar Network Analyzer can be used to make transmission loss or gain, return loss, absolute power, or alternating setup measurements.

3-4.1 Transmission and Return Loss Measurements

How to make a transmission and return loss measurement is described in Table 3-1; a test setup is shown in Figure 3-22.

3-4.2 Absolute Power Measurement

How to make an absolute power measurement is described in Table 3-2.

3-4.3 Alternate Setup Measurements

How to make an alternate setup measurement is described in Table 3-3. The alternate setup mode is controlled thru the 6600B Sweep Generator control panel but cannot be stored by the 6600B.

3-5 OPERATIONAL CHECKOUT

The 561 Scalar Network Analyzers undergo a comprehensive self test when turned on or when SELF TEST is selected. If the CRT displays "ALL TESTS PASSED," the internal circuits are operating properly. How to perform an operational check is described in Table 3-4.

3-6 ERROR MESSAGES

Upon turning on the equipment or selecting SELF TEST or RESET, the analyzer undergoes a comprehensive self test. If the self test passes, the message "ALL TESTS PASSED" displays; however, if any part of the self test fails, an error message displays. Additionally, a control panel LED flashes. A different LED flashes for each fault. The LED coding for fault detection is shown in Table 3-6. This coding makes it possible to locate a fault even if the CRT has failed.

3-7 561 ANALYZER CONNECTIONS TO WILTRON SWEEP GENERATORS

The 561 Scalar Network Analyzer may be used with various WILTRON and other sweep generators. Table 3-6 lists many of the models that may be used with the 561 and the interconnections required.

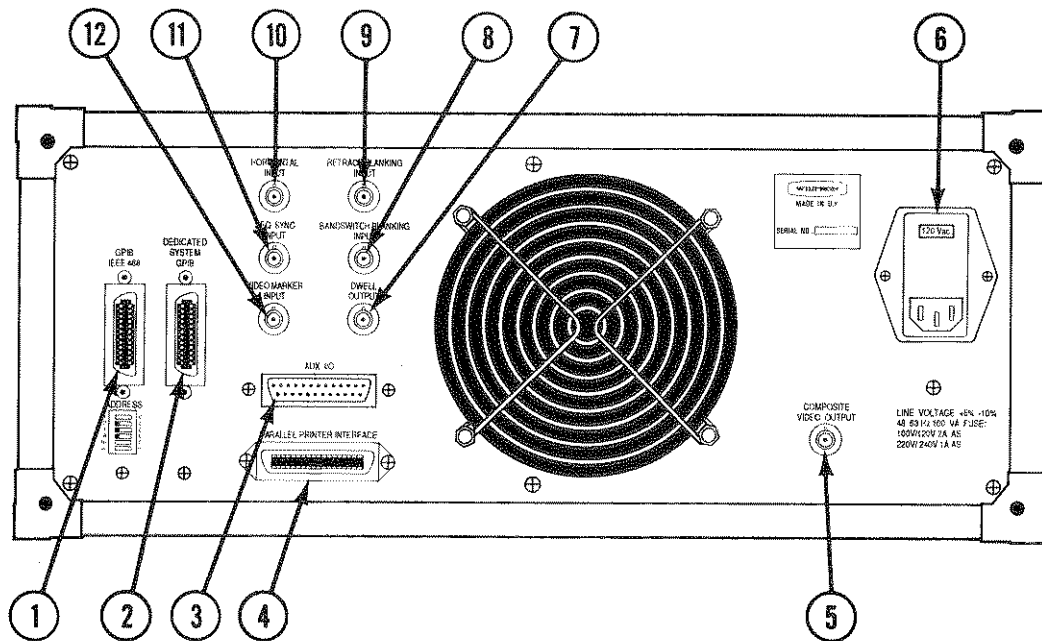

- ① **GPIB PANEL:** See Figure 2-2, page 2-4
- ② **DEDICATED GPIB:** Connects 561 to signal source and plotter.
- ③ **AUX I/O:** Connects 561 to Wiltron 6600B Sweep Generator, 6600A, or 6700A.
- ④ **PARALLEL PRINTER INTERFACE:** Provides standard Centronics parallel interface with a printer.
- ⑤ **COMPOSITE VIDEO OUTPUT:** Composite video signal. BNC connector.
- ⑥ **LINE VOLTAGE MODULE:** See Figure 2-1, page 2-4.
- ⑦ **SWEEP DWELL OUTPUT:** TTL-Low signal stops sweep. Sweep continues when signal is removed. BNC connector.
- ⑧ **BANDSWITCH BLANKING INPUT:** Accepts $\pm 5V$ signal coincident with bandswitching points. BNC connector.
- ⑨ **RETRACE BLANKING INPUT:** $\pm 5V$ blanks traces during retrace. BNC connector.
- ⑩ **HORIZONTAL SWEEP RAMP INPUT:** 0 to +10V nominal, +12V maximum. BNC connector, 100k ohm impedance.
- ⑪ **SEQUENTIAL SYNC INPUT:** +3.5V to +10V blanks trace during retrace or bandswitching. -3.5V to -10V defines a marker which when in the range of -8V to -10V is an active marker. BNC connector, 10K ohm impedance.
- ⑫ **VIDEO MARKER INPUT:** +2V to +10V peak input. BNC connector.

Figure 3-21. Rear Panel Connections

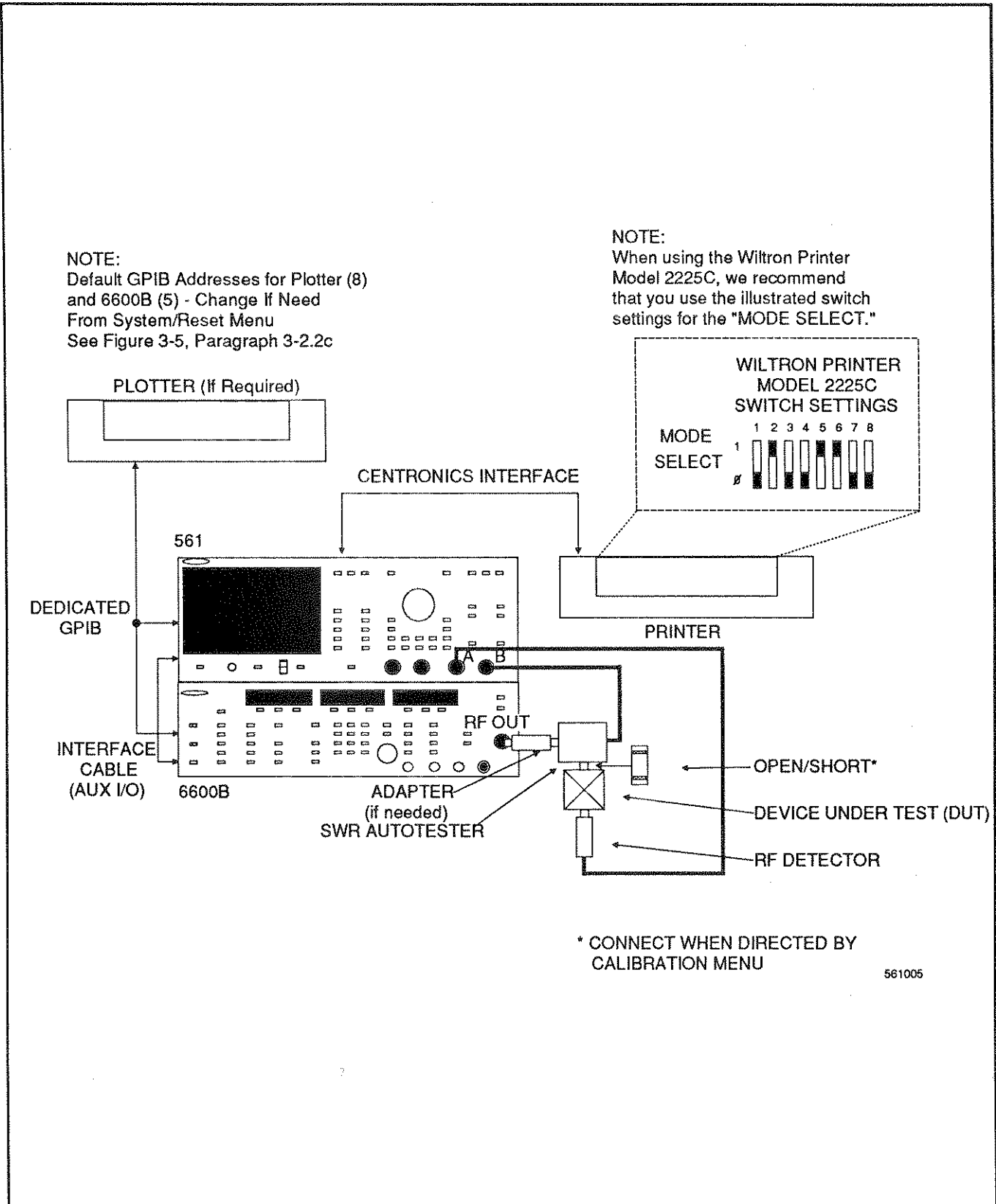
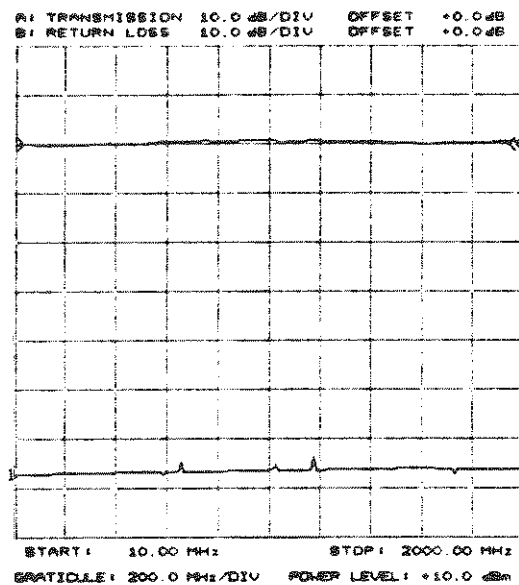

Figure 3-22. Measurements Test Setup

Table 3-1. Transmission and Return Loss Measurements

1. Connect test equipment per Figure 3-22, except do not connect the test device. Turn the printer on.
2. Turn on the 6600B sweep generator, then press POWER on the 561 to ON. At the conclusion of the built-in self test, the screen displays "ALL TESTS PASSED," and the CRT resembles that shown below. Control settings may be different from those shown, which are the RESET control settings*. The instrument comes on line with the same control settings it had when last turned off. Ensure that both channels are ON and that Channel 1 is set for TRANSMISSION and Channel 2 for RETURN LOSS.
3. Press the CALIBRATION key and follow the directions given in the calibration-cycle sequence of menus. If necessary, refer to Figure 3-10 for an explanation of the menus. After finishing the calibration, connect the test device and RF detector as shown in Figure 3-22.



Transmission Loss Measurement

4. Measure the transmission loss as follows:
 - a. Press the Channel 2 DISPLAY ON/OFF key to off.
 - b. Press the Channel 1 AUTOSCALE key. This gives an optimum vertical display of the test data.
5. Read the transmission loss by interpolating the displayed graphic, or read it directly using the main and/or delta cursors with the readout function as described in step 6. The transmission loss is approximately 0 dB in the pass band and 66 dB at the bottom of the skirt for the 2 GHz LPF shown on the following page.
6. To use the main cursor and delta cursor to read the results of the above measurement directly, proceed as follows:
 - a. For an absolute measurement press the Cursor ON/OFF to on, then position the cursor using the rotary knob or the "MOVE CURSOR TO CHANNEL PARAMETER—CH1" key in conjunction with the MENU SELECT key to the required measurement point.

* Reset conditions depend upon the sweep generator.

Table 3-1. Transmission and Return Loss Measurements (continued)

- b. If a relative measurement is required, then once the cursor has been positioned turn the cursor delta and the "MOVE CURSOR TO CHANNEL PARAMETER—CH 1" switch to ON, then select the desired parameter from the menu .
 - c. Read the resultant cursor delta position data from the menu screen.
7. Make a hard copy printout of the transmission loss as follows:
- a. Press the HARD COPY MENU key.
 - b. If device identify, date, and test device information is required, then select "TITLES "(paragraph 3-2.5 page 3-8).
 - c. Select PRINT GRAPH to print the displayed graphic, or select 26,51,101,201, or 401 to print a tabulation at the selected number of frequency points. You could also choose to print out a tabulation at only the marker frequencies, if any markers were on.
 - d. When using the Wiltron Model 2225C printer, verify that the rear switch settings are as shown in Figure 3-22. Also verify that the power indicator is on and that the reset indicator is not flashing. If it is, press the reset switch.
 - e. Press MENU SELECT or START PRINT to print out the data.
 - f. The printout should resemble the one shown below (Note: both transmission and return loss measurements are shown).
8. If a plotter is connected, by selecting the hardcopy menu you could choose to plot either graticules, traces, titling, cursor information or all of these items if the "Plot All" function is selected (see paragraph 3-2.5).

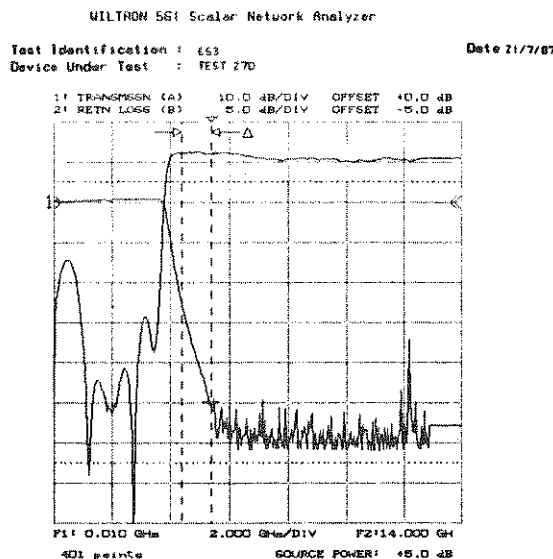

Return Loss Measurement

9. Measure the return loss of the device under test as follows:
- a. Press Channel 1 DISPLAY ON/OFF key to off.
 - b. Press Channel 2 DISPLAY ON/OFF key to on.
 - c. Press Channel 2 AUTOSCALE key.
10. To use the cursor function to read the results of the return loss measurement directly, repeat step 6 above.
11. Print out the return loss as described in step 7 above.

Table 3-2. Absolute Power Measurement

1. Connect the RF detector between Connector A and the RF output connector as shown below.
2. Press POWER on the analyzer to on. At the conclusion of the built-in self test the screen displays "ALL TESTS PASSED." Control settings may be different from those shown, which are the factory RESET control settings. The instrument comes on line with the same control setting it had when last turned off.

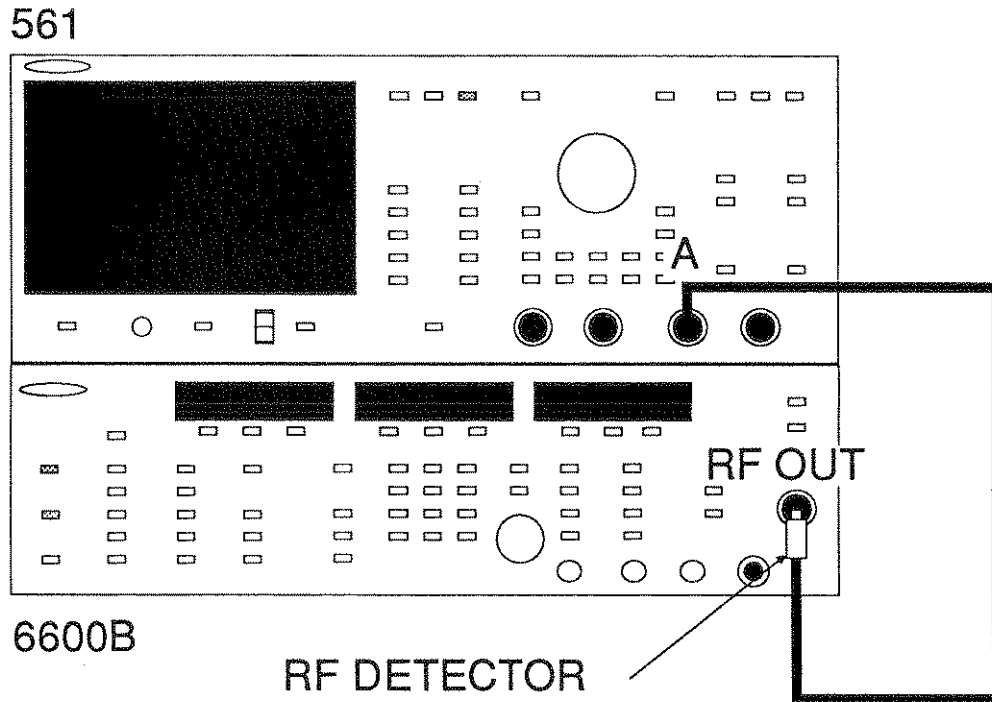

561004

3. Press the channel 2 DISPLAY ON/OFF key to off.
4. Press the channel 1 MENU key.
5. When the menu appears, select the POWER option using the MENU rocker switch and SELECT key.
6. Press the Channel 1 AUTOSCALE key. This gives an optimum vertical display of the test data.
7. Press the CURSOR ON/OFF key to on.
8. Using the DATA ENTRY rotary knob or the "MOVE CURSOR TO CHANNEL PARAMETER—CH1" key in conjunction with the MENU SELECT switch, move the cursor from the low to the high ends of the trace and read the source output power, in dBm, at the frequencies of interest.

Table 3-3. Alternate Setup Measurements

1. Connect test equipment per Figure 3-23, except do not connect the test device. Turn the printer on.
2. Turn on the 6600B and 561. At the conclusion of the built-in self test, the screen displays "ALL TESTS PASSED." Control settings may be different from those shown, which are the RESET control setting. The instrument comes on line with the same control settings it had when last turned off.
3. Set Channels 1 and 2 to display transmission using input A, as follows:
 - a. Press the CH1 MENU key.
 - b. Move the cursor to highlight TRANSMISSION and press the SELECT key.
 - c. Move the cursor to highlight SELECT INPUT and press the SELECT key.
 - d. Move the cursor to highlight A and press the SELECT key.
 - e. Repeat steps a thru d for channel 2.
4. On the 6600B, select an alternating setup as follows:
 - a. Press the FULL key.
 - b. Press the SHIFT key.
 - c. Press the SAVE key.
 - d. Select "1" on the keypad.
 - e. Press the Δ F CF key.
 - f. Press the ALT SETUP and "1" keys.
5. On the 561, press the CALIBRATION key and follow the directions given in the calibration-cycle sequence of menus. If necessary, refer to Figure 3-10 for an explanation of the menus. After finishing the calibration, connect the test device and RF detector as shown in Figure 3-23.
6. On the 561, measure the transmission loss in the Alternating Sweep mode as follows:
 - a. Press the Channel 1 AUTOSCALE key. This gives an optimum vertical display of the test data.
 - b. Read the transmission loss by interpolating the displayed graphic, or read it directly using main and delta cursors and the readout function per step 7 below. This is the transmission loss for the normal source input.
 - c. Repeat steps a and b for channel 2. This is the transmission loss for the alternate source input. If different alternative measurements are needed, then new calibration may be required (see paragraph 3-2.2a).
7. Make a hard copy printout of the transmission loss as follows:
 - a. Press the HARD COPY Menu key.
 - b. If device identify, date, and test device information are required to be annotated on hard copy, these can be entered by selecting TITLES (paragraph 3-2.5 page 3-8).
 - c. Select PRINT GRAPH to print the displayed graphic, or select 26, 51, 101, 201, or 401 to print a tabulation at the selected number of frequency points. You could also choose to print out a tabulation at only the marker frequencies, if any markers were on.
 - d. When using the Wiltron Model 2225C printer, verify that its rear switch settings are as shown in Figure 3-23. Also verify that the power indicator is on and that its reset indicator is not flashing. If it is, press the reset switch.
 - e. Press MENU SELECT or START PRINT to print out the data.
 - f. The printout should resemble the one shown in Figure 3-14.
8. Measure the return loss of the device under test as follows:
 - a. Repeat steps 3 a thru d, except choose RETURN LOSS instead of TRANSMISSION.
 - b. Repeat step 6 for a return loss measurement.
9. Print out the return loss as directed in step 7 above.

NOTE:
 Default GPIB Addresses for Plotter (8)
 and 6600B (5) - Change If Need
 From System/Reset Menu
 See Figure 3-5, Paragraph 3-2.2c

NOTE:
 When using the Wiltron Printer
 Model 2225C, we recommend
 that you use the illustrated switch
 settings for the "MODE SELECT."

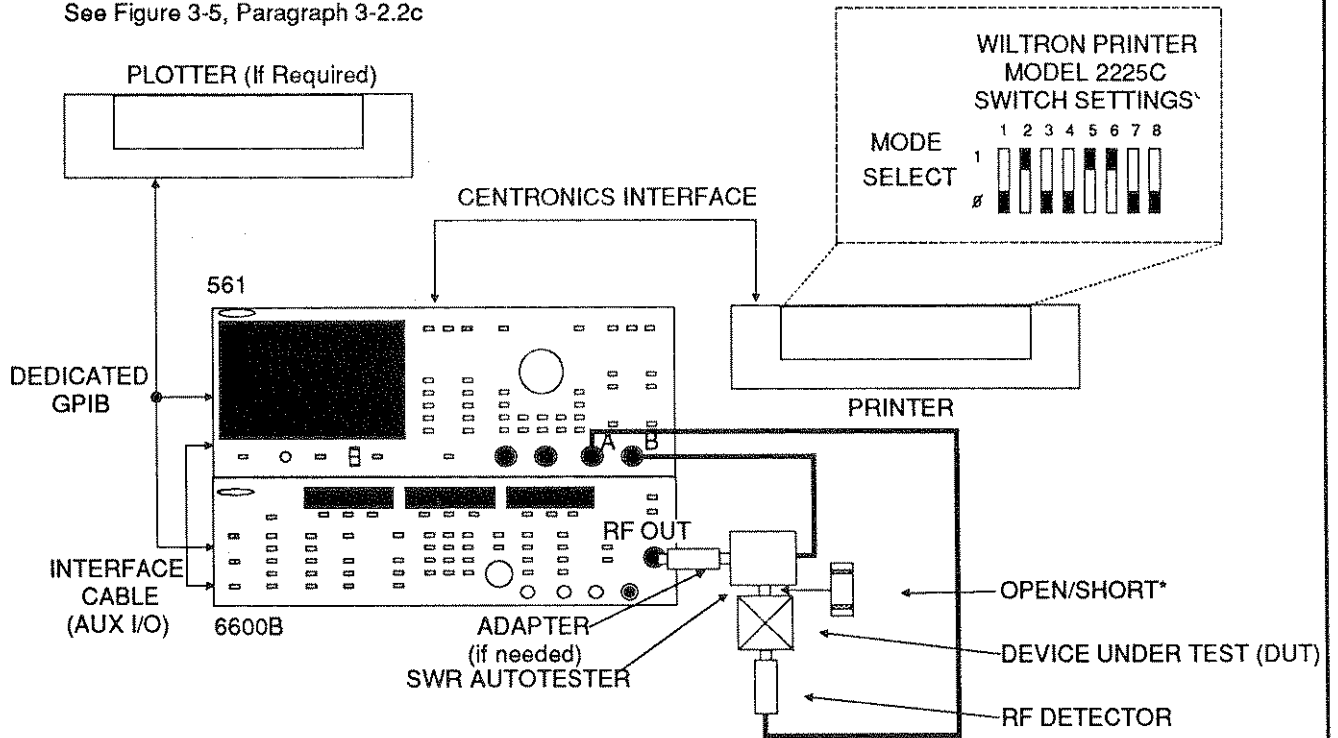

* CONNECT WHEN DIRECTED BY
 CALIBRATION MENU

561005

Figure 3-22. Measurements Test Setup

Table 3-4. Operational Checkout Procedure

1. Connect the RF detector between Channel A of the analyzer and the RF output of the source as shown below.

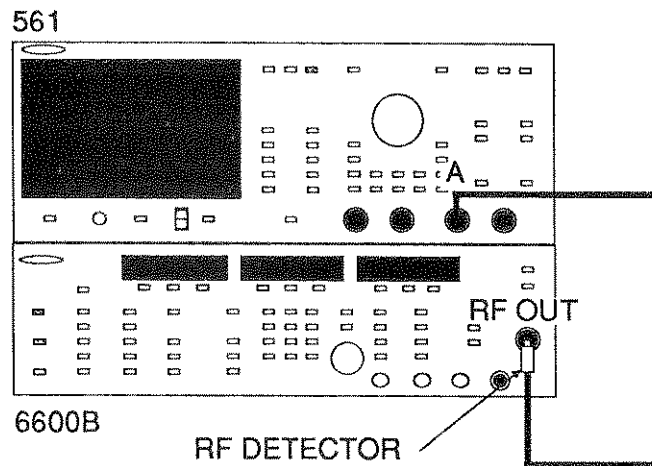

2. Press POWER on the analyzer to on. At the conclusion of the built-in self test, the screen displays "ALL TESTS PASSED." Press the SYSTEM RESET key and select the RESET option with the MENU SELECT switch (returns the system to the factory settings).
3. Press the Graticule ON/OFF key.
4. Press the Channel 2 DISPLAY ON/OFF key to off.
5. Press the Channel 1 MENU key.
6. When the menu appears, select the POWER option using the MENU Up/Down switch and SELECT key.
7. Press the Channel 1 OFFSET/RESOLUTION key.
8. When the menu appears, select the OFFSET option and enter 10 dB via the DATA ENTRY keypad and the ENTER switch.
9. Observe that the trace deflects downward by 1 division.
10. Select the RESOLUTION option and enter 2 dB using the DATA ENTRY keypad or rotary knob.
11. On the power source, select a level of 2 dBm.
12. Observe that the trace deflects downward by 4 divisions.

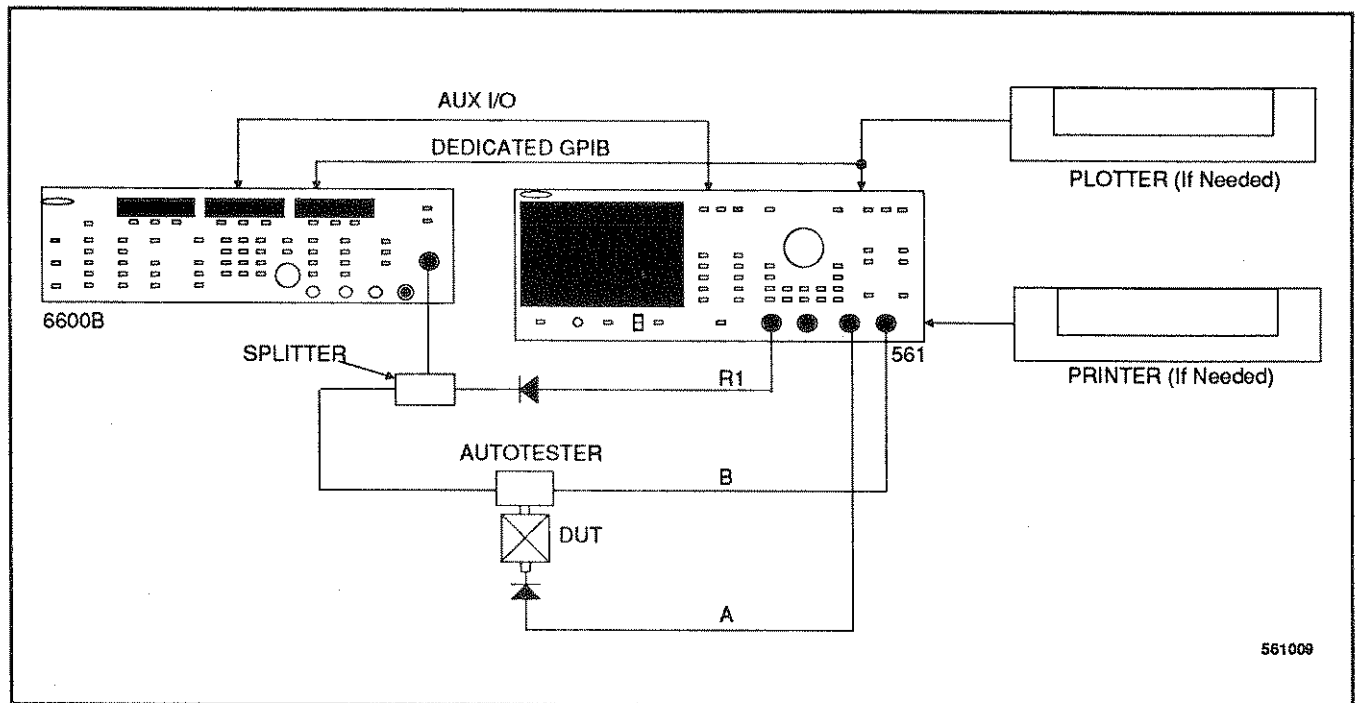

Figure 3-24. Test Setup for Ratio Mode Measurements

Table 3-5. Ratio Mode Measurements

1. Connect test equipment per Figure 3-24, except do not connect the test device. Turn the printer (or plotter) on.
2. Turn on the 6600B and 561. At the conclusion of self test, the screen displays "ALL TESTS PASSED." Control settings may be different from those shown, which are the factory reset control settings. The instrument comes on line with the same control setting it had when last turned off.
3. Select transmission mode and ratio input A/R1 for channel 1, and return loss and ratio input B/R1 for channel 2 (section 3-2.3b).
4. On the 561, press the CALIBRATION key and follow the directions given in the calibration-cycle sequence of menus. If necessary, refer to Figure 3-10 for an explanation of the menus. After finishing the calibration, connect the test device and RF detector as shown in Figure 3-24.
5. On the 561, measure the transmission loss in the ratio mode as follows:
 - a. Press the channel 1 AUTOSCALE key. This gives an optimum vertical display of the test data.
 - b. Read the transmission loss by interpolating the displayed graphic, or read it directly by using main and delta cursors and the readout function per step 6 below. This is the transmission loss for the A/R1 ratio mode input.
6. To use the main cursor and delta cursor to read the results of the above measurement directly, proceed as follows:
 - a. Press the cursor ON/OFF to ON, then position the cursor using the rotary knob or the "MOVE CURSOR TO CHANNEL PARAMETER—CH1" switch in conjunction with the MENU SELECT switch.

Table 3-5. Ratio Mode Measurements (Continued)

- b. Turn the cursor delta and the "MOVE CURSOR TO CHANNEL PARAMETER—CH1" switch to ON, then select the desired parameter from the menu.
 - c. Read the resultant cursor position data from the menu screen.
7. Make a hard copy printout of the transmission loss as follows:
 - a. Press the HARD COPY Menu key.
 - b. Select PRINT GRAPH to print the displayed graphic, or select 26,51,101, 201, or 401 to print out a tabulation at the selected number of frequency points. You could also choose to print out a tabulation at only the marker frequencies, if any markers were on.
 - c. When using the WILTRON Model 2225C printer, verify that the rear switch settings are as shown in Figure 3-23. Also verify that the power indicator is on and that the reset indicator is not flashing. If it is, press the reset switch.
 - d. Press MENU SELECT or START PRINT to print out the data.
 - e. The printout should resemble the one shown in Figure 3-14.
8. On the 561, measure the return loss in the ratio mode as follows:
 - a. Press the channel 2 AUTOSCALE key. This gives an optimum vertical display of the test data.
 - b. Read the return loss by interpolating the displayed graphic, or read it directly by using main and delta cursors and the readout function per step 6 above. This is the return loss for the B/R1 ratio mode input.
9. Print out the return loss as directed in step 7 above.

Table 3-6. Control Panel LED Error Codes

FLASHING LED*	FAULT	FAULT LOCATION
HOLD (Initial Turn On)	No Communication With 2nd C.P.U.	A6
CHANNEL 1 (Initial Turn On)	Unable To Send Self Test To Sweeper	
CURSOR ON/OFF (Initial Turn On)	Fatal Error While Attempting To Calibrate Ramp	A4
CHANNEL 2	Ramp Not Calibrated	A4, or Sweep Ramp Too Slow
CHANNEL 1	CPU EPROM Checksum	A5 (Observe Initial Test To Identify)
AVERAGING	U22 RAM	A5
SMOOTHING MINIMUM	Front Panel Key; Error	A13
SMOOTHING OFF	U23 RAM	A5
SMOOTHING MAXIMUM	System GPIB	A8
CAL BEGIN	Dedicated GPIB	A10
UNCAL	ADC Converter	A3
CURSOR	Test Reading Failed	A3 (A1/A2)
DELTA CURSOR	Channel A/B Null/Zero Failure/PCB Missing	A2 (A3)
REMOTE	Channel R1/R2 Null/Zero Failure/PCB Missing	A1 (A3)
HOLD	Tick/Time Scheduling Failure	A9/A5

* After a period of flashing, the option is given, at the users discretion to continue to attempt operation by pressing SELECT.

Table 3-7. Interconnections, 561 to WILTRON and Other Sweep Generators

561 to WILTRON 6600A*/B		561 to WILTRON 610D	
561 CONNECTOR	6600A/B CONNECTOR	561 CONNECTOR	610D* CONNECTOR
AUX I/O Dedicated GPIB	AUX I/O GPIB	HORIZ IN SEQ SYNC VIDEO MARKER RETRACE BLANKING BANDSWITCH BLANKING DWELL OUTPUT	HORIZ OUT SEQ SYNC VARIABLE MARKER OUTPUT +6V DURING RETRACE +10V DURING BANDSWITCH DWELL INPUT
* 6600A with retrofit kit installed for operation with the 561.		* 610D requires Option 8.	
561 to WILTRON 6600A*/B—Using Discrete Cables		561 to hp 8350A/B	
561 CONNECTOR	6600A/B CONNECTOR	561 CONNECTOR	8360A/B CONNECTOR
HORIZ IN SEQ SYNC VIDEO MARKER RETRACE BLANKING BANDSWITCH BLANKING DWELL OUTPUT	HORIZ OUT SEQ SYNC MARKERS OUTPUT NO CONNECTION NO CONNECTION SWEEP DWELL INPUT	HORIZ IN SEQ SYNC VIDEO MARKER RETRACE BLANKING BANDSWITCH BLANKING DWELL OUTPUT	SWEEP OUTPUT POSZ BLANK NO CONNECTION NO CONNECTION NO CONNECTION STOP SWEEP
* 6600A with retrofit kit installed for operation with the 561.		561 to hp 8620C	
561 to WILTRON 6700A		561 CONNECTOR	8620C CONNECTOR
561 CONNECTOR	6700A CONNECTOR	HORIZ IN SEQ SYNC VIDEO MARKER RETRACE BLANKING BANDSWITCH BLANKING DWELL OUTPUT	SWEEP OUTPUT POSZ BLANK NO CONNECTION NO CONNECTION NO CONNECTION STOP SWEEP (Pin 34 of the 50-pin connector)
AUX I/O Dedicated GPIB	AUX I/O GPIB	561 to WILTRON 6700A—Using Discrete Cables	
561 CONNECTOR	6700A CONNECTOR	561 CONNECTOR	8620C CONNECTOR
HORIZ IN SEQ SYNC VIDEO MARKER RETRACE BLANKING BANDSWITCH BLANKING DWELL OUTPUT	HORIZ OUT SEQ SYNC MARKERS OUTPUT NO CONNECTION NO CONNECTION SWEEP DWELL INPUT	HORIZ IN SEQ SYNC VIDEO MARKER RETRACE BLANKING BANDSWITCH BLANKING DWELL OUTPUT	SWEEP OUTPUT POSZ BLANK NO CONNECTION NO CONNECTION NO CONNECTION STOP SWEEP (Pin 34 of the 50-pin connector)

SECTION IV REMOTE (GPIB) OPERATION

CONTENTS

Paragraph	Title	Page
4-1	INTRODUCTION	4-3
4-2	DESCRIPTION OF THE IEEE-488 INTERFACE BUS	4-3
	4-2.1 Data Bus Description	4-3
	4-2.2 Management Bus Description	4-3
	4-2.3 Data Byte Transfer Control (Handshake) Bus Description	4-4
4-3	GPIB OPERATION	4-4
4-4	COMMAND CODES, DESCRIPTIONS	4-4
4-5	BUS MESSAGES, ANALYZER RESPONSE TO	4-5
4-6	ALPHABETICAL INDEX TO ANALYZER COMMAND CODES	4-5

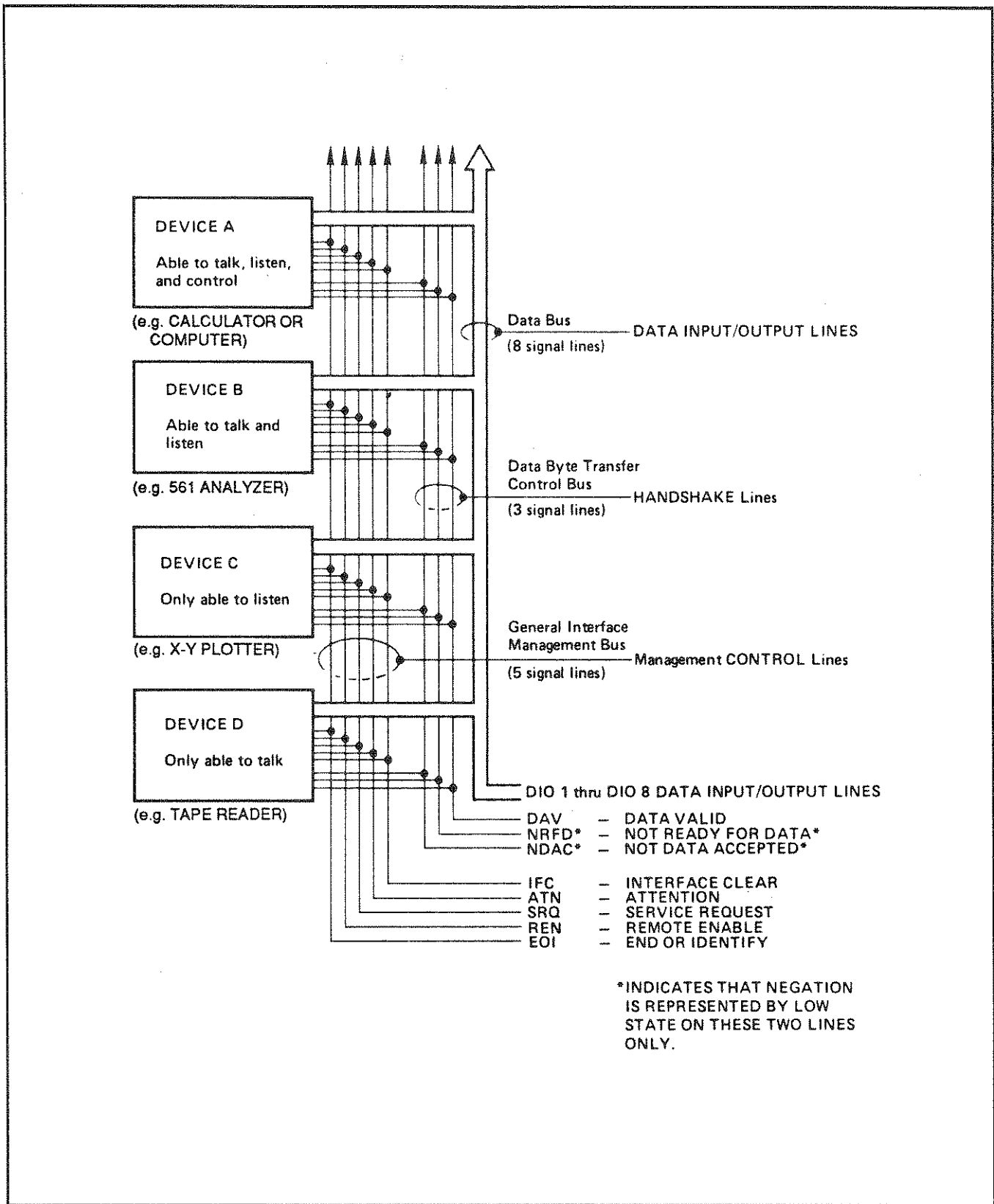

Figure 4-1. Interface Connections and Bus Structure

SECTION IV REMOTE (GPIB) OPERATION

4-1 INTRODUCTION

This section provides a description of the GPIB and the analyzer command codes. It also provides several examples of bus programming.

4-2 DESCRIPTION OF THE IEEE-488 INTERFACE BUS

The IEEE-488 bus (General Purpose Interface Bus, or GPIB) is an instrumentation interface for integrating instruments, calculators, and computers into systems. The bus uses 16 signal lines to effect transfer of data and commands to as many as 15 instruments.

The instruments on the bus are connected in parallel, as shown in Figure 4-1 on the facing page. Eight of the signal lines (DIO 1 thru DIO 8) are used for the transfer of data and other messages in a byte-serial, bit-parallel form. The remaining eight lines are used for communications timing (handshake), control, and status information. Data is transmitted as eight-bit characters, referred to as bytes. Normally, a seven-bit ASCII (American Standard Code for Information Interchange) code is used. The eighth (parity) bit is not used. Data is transferred using an interlocked handshake technique.

This technique permits asynchronous communications over a wide range of data rates. The following paragraphs provide an overview of the data, management, and handshake buses, and describe how these buses interface with the analyzer.

4-2.1 Data Bus Description

The data bus is the conduit for transmitting control information and data between the controller and the analyzer. It contains eight bi-directional, active-low signal lines—DIO 1 thru DIO 8. One byte of information (eight bits) is transferred over the bus at a time. DIO 1 represents the least-significant bit (LSB) in

this byte and DIO 8 represents the most-significant bit (MSB). Each byte represents a peripheral address (either primary or secondary), a control word, or a data byte. Data bytes are usually formatted in ASCII code, without parity.

4-2.2 Management Bus Description

The management bus is a group of five signal lines used to control the operation of the bus system. Functional information regarding the individual control lines is provided below.

- a. **ATN (Attention)**
When TRUE, the analyzer responds to appropriate interface messages—such as, device clear and serial poll—and to its own listen/talk address.
- b. **EOI (End Or Identify)**
When TRUE, the last byte of a multibyte message has been placed on the line. Also used in conjunction with ATN to indicate a parallel port.
- c. **IFC (Interface Clear)**
When TRUE, the analyzer interface functions are placed in a known state—such as, unaddressed to talk, unaddressed to listen, and service request idle.
- d. **REN (Remote Enable)**
When TRUE, the analyzer is enabled—upon receipt of its listen address—for entry into the remote state. The mode is exited either when the REN line goes FALSE (high) or when the analyzer receives a go-to-local (GTL) message.
- e. **SRQ (Service Request)**
This line is pulled LOW (true) by the analyzer to indicate that certain preprogrammed conditions exist.

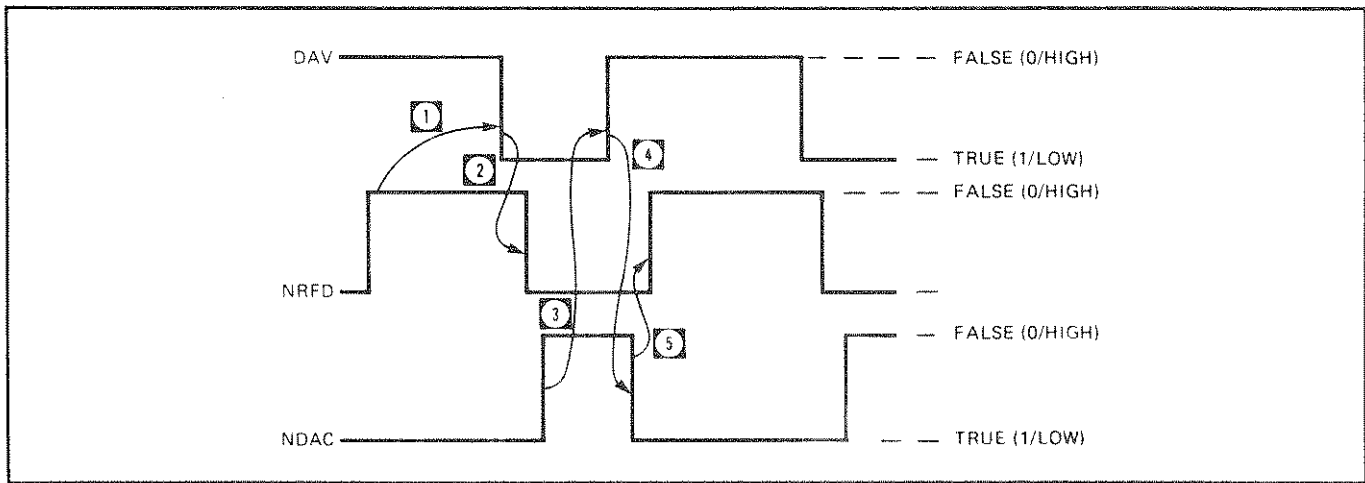

Figure 4-2. Typical Handshake Operation

4-2.3 Data Byte Transfer Control (Handshake) Bus Description

Information is transferred on the data lines by a technique called the three-wire handshake. The three handshake-bus signal lines (Figure 4-2) are described below.

- a. **DAV (Data Valid)**
Goes TRUE (arrow 1) when the talker has (1) sensed that NRFD is FALSE, (2) placed a byte of data on the bus, and (3) waited an appropriate length of time for the data to settle.
- b. **NRFD (Not Ready For Data)**
Goes TRUE (arrow 2) when a listener indicates that valid data has not yet been accepted. The time between the events shown by arrows 1 and 2 is variable and depends upon the speed with which a listener can accept the information.
- c. **NDAC (Not Data Accepted)**
Goes FALSE to indicate that a listener has accepted the current data byte for internal processing. When the data byte has been accepted, the listener releases its hold on NDAC and allows the line to go FALSE. However, since the GPIB is constructed in a wired-OR configuration, NDAC will not go FALSE until all listeners participating in the interchange have also released the line. As shown by arrow 3, when NDAC goes FALSE, DAV follows suit a short time later. The FALSE state of DAV indicates that valid data has been removed; consequently, NDAC goes LOW in preparation for the next data interchange (arrow 4).

Arrow 5 shows the next action in time: NRFD going FALSE after NDAC has returned TRUE. The FALSE state of NRFD indicates that all listeners are ready for the next information interchange. The time between these last two events is variable and depends on how long it takes a listener to process the data byte. In summation, the wired-OR construction forces a talker to wait for the slowest instrument to accept the current data byte before placing a new data byte on the bus.

4-3 GPIB OPERATION

All front panel keys are bus controllable. When used on the GPIB, the analyzer functions as both a listener and a talker. Table 4-1 provides a listing of the GPIB subset functions.

4-4 COMMAND CODES, DESCRIPTIONS

The command codes recognized by the 561 are listed in Tables 4-2 thru 4-10.

4-4.1 Inputting Restrictions and Notes

To initiate a GPIB command mnemonic, enter the command together with any required parameters. You may use a space to separate the command and parameter(s), but you do not have to. Also, you may enter several commands on the line; however, each must be separated by a valid delimiter. We recommend using a comma as the delimiter. Other valid delimiters are the colon (:), hyphen (-), asterisk (*), dollar sign (\$), virgule (/), reverse virgule (\), space (), and semicolon (;). The following is an example of a valid command structure.

Table 4-1. 561 IEEE-488 Bus Subset Capability

GPIB SUBSET	FUNCTION	DESCRIPTION
AH1	Acceptor Handshake	Complete Capability
SH1	Source Handshake	Complete Capability
T6	Talker	No Talk Only (TON)
TE0	Talker With Address Extension	No Capability
L4	Listener	No Listen Only (LON)
LE0	Listener With Address Extension	No Capability
SR1	Service Request	Complete Capability
RL1	Remote/Local	Complete Capability
PP1	Parallel Poll	Complete Capability
DC1	Device Clear	Complete Capability
DT1	Device Trigger	No Capability
C1, C2, C3, C28	Controller	No Capability

SI1 A, SM1 R, OFF 1 20 dB, GON, CRF 1 99GHz, OCF 1

The above command string would do the following:

1. Set the channel 1 signal trace to be from input A
2. Set the measurement type to be displayed on channel 1 and to be the return loss of the test device.
3. Set the channel 1 offset to be 20 dB.
4. Turn on the graticule grid display.
5. Move the cursor to 99 GHz on the channel 1 trace.
6. Return to the controller the cursor frequency for channel 1.

4-4.2 Reserved Mnemonics

In writing command strings, the following mnemonics may be used for clarity, or they may be omitted for brevity: dB, dBm, GHz, MHz. If the units of frequency (MHz, GHz) are not specified, GHz is assumed.

4-5 BUS MESSAGES, ANALYZER RESPONSE TO

Table 4-11 (page 4-20) lists the bus messages responded to by the analyzer. Table 4-12 (page 4-21) lists programming statements showing how the WILTRON 85 and HP Series 200 bus controllers implement the recognized bus messages.

4-6 ALPHABETICAL INDEX TO ANALYZER COMMAND CODES

Table 4-13 (pages 4-22) provides an alphabetical index to the analyzer command codes.

Table 4-2. Command Codes: Display Channel Control

The following is a list of Mnemonic parameters as indicated within parenthesis: N = 1 or 2 for channel selection n = a number within range +/-99.99 F = a frequency within range +/-0 to 999.9999 GHz S = 0 or 1 for ON/OFF indication (1 = ON, 0 = OFF) M = 1 to 9, Marker numbers, used for SAVE, RECALL, STORE Marker#, etc. P = 0 to 400, to select pixel position X = a variable that will be defined next to the instruction or Mnemonic		
COMMAND CODE	MNEMONIC	FUNCTION
SI1(X) SI2(X)	Set Input For Channel 1 Set Input For Channel 2	Selects input to be displayed on selected channel, where X is the input combination: that is A, B, R1, R2, A/R1, B/R1, A/R2, or B/R2. For example, bus command "SI2 B/R2" sets the signal ratio of Input B/Input R2. This input is displayed as the Channel 2 trace signal.
SM1(X) SM2(X)	Set Channel 1 Display Set Channel 2 Display	Sets measurement type to be displayed on selected channel. In this case X equals P (power), R (return loss), T (transmission), C(calibration data), or O (turn off channel). For example, bus command "SM2R" sets channel 2 to measure the return loss of the device under test. Bus command "SI1 A, SM1 P" then sets channel 1 to display Input A, and sets the displayed signal to be a measure of absolute power in dBm.
CH1(S) CH2(S)	Set Channel 1 On/Off Set Channel 2 On/Off	Turns the selected channel on or off. For example, bus command "CH1 1" turns channel 1 ON and allows it to display a signal trace.
RON(N) ROF(N)	Reference Display On Reference Display Off	Turns On/Off the reference line. The position is displayed by a chevron "<" and a line drawn across the screen display. The default display is ROF which displays the reference line position using the chevron "<".
REF(N)(X)	Position	Sets reference line to position "X" on selected channel, where X= 0 to 10. In this case, the top of the screen equals 0, and the bottom of the screen equals 10. For example, bus command "REF 15" places the reference line for trace 1 at the fifth line from the top.
OFF(N)(n)	Offset (dB)	Sets the Offset on the selected channel. For example, bus-command "OFF 2 10 dB" sets the trace offset on channel 2 to 10 dB.
SCL(N)(X)	Resolution (dB/div.)	Sets the Resolution of the selected channel to X dB / division, where X = 0.1 to 10 dB/div in any 0.1 dB increment.
TCR(N)	Trace At Cursor to Reference Line	Automatically adjusts the offset such that the trace at the cursor is placed on the reference line for channel N.

Table 4-2. Command Codes: Display Channel Control (Continued)

COMMAND CODE	MNEMONIC	FUNCTION
LHI(N)(n) LHF(N) LLO(N)(n) LLF(N)	High Limit On High Limit Off Low Limit On Low Limit Off	Sets the straight line limits to n dB on the selected channel or turns off the limits. The limits can be used as a guide to test signal trace response. Setting these limits cancel any complex limits previously sent for that channel.
CLH(N)(limits) CLL(N)(limits)	Enter Complex Limits High Enter Complex Limits Low	Sets the complex limits on the selected channel. See Appendix for format of data. See Figure 4-3 for a programming example.
OLT(N)	Output Limits Test Result	Returns a pass/fail message to the controller. If the test fails, the failed frequency in Ghz is returned with the fail message.
DLT	Display Limits Test	Displays a menu that performs pass/fail testing on every sweep for pre-entered limits.
ASC(N)	Autoscale	Automatically adjusts the resolution and offset to fit the signal trace for channel N on the screen.
GSN GSF	GPIB Status Indication On GPIB Status Indication Off	Turns the GPIB status indication display on. Turns the GPIB status indication display off

Bus Command: CLH 1 1 900MHz 4GHZ -3DB 7 DB
 2 4GHZ 6GHZ 7DB -20.03DB
 (Mnemonics may be in either upper or lower case, or mixed.)

The above command sets the high values of complex limits for channel 1, the order in which data is entered us as follow:

- Segment Number
- Start Frequency
- Stop Frequency
- Limit Value At Start Frequency
- Limit Value at Stop Frequency

The above command illustrates setting the complex limits for segments 1 and 2. For the frequency parameter, if "GHz" or "MHz" is not entered, then the frequency defaults to GHz.

The "dB" mnemonic as used in the string is optional and may be used to improve readability.

There are ten valid segments (1 - 10), a complete set of segment values may be entered using a single command, or each segment may be entered individually.

The data is entered in an ASCII format.

Figure 4-3. Programming Example: Complex Limits

Table 4-3. Command Codes: Calibration, Graticule Display, System Functions, Diagnostic Facilities, Averaging, Smoothing.

The following is a list of Mnemonic parameters as indicated within parenthesis: N = 1 or 2 for channel selection n = a number within range +/-99.99 F = a frequency within range +/-0 to 999.9999 GHz S = 0 or 1 for ON/OFF indication (1 = ON, 0 = OFF) M = 1 to 9, Marker numbers, used for SAVE, RECALL, STORE Marker#, etc. P = 0 to 400, to select pixel position X = a variable that will be defined next to the instruction or Mnemonic		
COMMAND CODE	MNEMONIC	FUNCTION
CALIBRATION		
CAL	Calibrate the 561	Initiates the calibration sequence on the 561.
GRATICULE DISPLAY		
GON	Turn Graticule On	Turns the graticule grid display on.
GOF	Turn Graticule Off	Turns the graticule grid display off leaving small tick marks.
SYSTEM FUNCTIONS		
SVS(M)	Save Front Panel Setup	Saves the current control panel setup to memory M.
SVC(X)	Save Setup with Calibration Data	Saves the current control panel setup together with all relevant calibration data to memory X, where X = 1 to 4.
RCS(M)	Recall Setup	Recalls the control panel setup from memory M.
RCC(X)	Recall with Calibration Data	Recalls the control panel setup from memory X (X = 1 to 4), together with calibration data.
PRV(X)	Preview	Looks at control panel setup X (X=1 to 9) from memory without recall. If an intelligent sweeper is connected, it's setup is also displayed. When Preview mode is selected, only the following functions are allowed: other Preview setups, stop print function, and print graph function. Mnemonic command "PRV 0" deselects the Preview mode.
DIAGNOSTIC FACILITIES		
TST	Test	Runs the instrument self test routine. The result of the test is available in the extended status byte.
RST	Reset	Resets the instrument to factory default settings. If an intelligent sweeper is connected to the 561, this too will be reset.
FREQUENCY DATA POINTS		
DP1	Set Resolution to 101 Data Points	Sets the screen display resolution to 101, 201, or 401 data points. 101 and 201 are only valid when smoothing is off, else the DP instruction will only take effect when returning to smoothing off.
DP2	Set Resolution to 201 Data Points	
DP4	Set Resolution to 401 Data Points	

Table 4-3. Command Codes: Calibration, Graticule Display, System Functions, Diagnostic Facilities, Averaging, Smoothing. (Continued)

COMMAND CODE	MNEMONIC	FUNCTION
AVERAGING		
AVG(X) AOF	Averaging On Averaging Off	Turns the averaging function on or off. The number of sweeps averaged is equal to 2 raised to the power X, where X = 2 to 8.
SMOOTHING		
SON(X) SOF	Smoothing ON Smoothing Off	Controls the on/off and minimum/maximum states of the signal trace smoothing function where X = 0, 1, or 2. When X is 0, smoothing is off; X = 1, minimum smoothing; X = 2, maximum smoothing

Table 4-4. Command Codes: Service Request

COMMAND CODE	MNEMONIC	FUNCTION
SQ1 SQ0	Enable SRQ Disables SRQ	The 561 defaults to SQ0, SRQ being disabled.
SQS(X)	Program Number of Sweeps	After X number of sweeps, an SRQ will be generated.
IPM(X)	Input Primary Mask	Provides an 8-bit mask (X) for the primary status byte. The mask argument (X) can be a number from 0 to 255. The default value is zero. See Figure 4-4 for an example of the status bytes and how they are used.
IEM(X)	Input Extended Mask	Provides an 8-bit mask (X) for the extended status byte. The mask argument (X) can be a number from 0 to 255. The default value is zero.
CSB	Clear Primary Status Byte	Clears the primary status byte.

Bus Command: IPM 135

The argument 135 sets the primary status mask to enable bits 0, 1, 2, and 7 in the primary status byte (see below).

NOTE

The Service Request bit (6) in the primary status byte is not maskable. Separate mnemonics exist for enabling and disabling the SRQs.

STATUS BYTE
Binary Byte Decoding

7	6	5	4	3	2	1	0
128	64	32	16	8	4	2	1

Primary Status Byte

7	6	5	4	3	2	1	0
---	---	---	---	---	---	---	---

All bits except 6 will generate an SRQ when set to a 1 (high).

Bit	Function
0	Provides an SRQ after a programmed number of sweeps have been completed.
1	Syntax error.
2	Calibration sweep finished.
3	Not used.
4	Redirection mode failure. Sets for any error associated with attempting to program an instrument on the dedicated GPIB.
5	Extended status byte contains valid information.
6	Service request bit.
7	Redirected SRQ. Sets when any instrument on the dedicated GPIB has requested service. See Figure 4-5 for an explanation.

Extended Status Byte

7	6	5	4	3	2	1	0
---	---	---	---	---	---	---	---

Bits 0, 1, and 2 will contain status information and will also generate a service request. The remaining bits are status bits only.

Bit	Function
0	Print finished = 0 (will generate an SRQ.) Print failed = 1
1	Plot finished = 0 (will generate an SRQ.) Plot failed = 1
2	Last print request failed (will generate an SRQ).
3	561 is uncalibrated.
4	561 is in calibration mode.
5	561 is in secret mode.
6	561 self test failed.
7	Preview mode currently selected.

Figure 4-4. Programming Example: Service Request

When an instrument on the dedicated GPIB requests service, bit 7 in the primary status byte is set. This generates an SRQ. Two data bytes are available to be read. They will indicate which instrument on the dedicated GPIB has requested service and its status. The first byte contains the status information. The second byte contains the address of the instrument requesting service, see below.

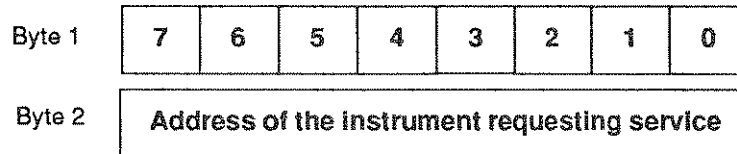

Figure 4-5. Redirected Status Byte

Table 4-5. Command Codes: Cursor Control and Search Facility

The following is a list of Mnemonic parameters as indicated within parenthesis:

- N = 1 or 2 for channel selection
- n = a number within range +/-99.99
- F = a frequency within range +/-0 to 999.9999 GHz
- S = 0 or 1 for ON/OFF indication (1 = ON, 0 = OFF)
- M = 1 to 9, Marker numbers, used for SAVE, RECALL, STORE Marker#, etc.
- P = 0 to 400, to select pixel position
- X = a variable that will be defined next to the instruction or Mnemonic

COMMAND CODE	MNEMONIC	FUNCTION
CURSOR CONTROL		
COF	Cursor Off	Controls the movement of the main or reference cursor, either by specifying position or frequency, and also the on/off states of the cursors. EXAMPLE: Bus command RCF 1 20 GHz will move the reference cursor to a frequency of 20 GHz on the channel 1 trace. This is the delta-cursor operation. This is a Delta Cursor function and requires the Delta Mode to be selected.
CON	Cursor ON	
CRP(P)	Move Cursor to Position P	
CRF(N)(F)	Move Cursor to Frequency F	
DON	Delta Mode On	
DOF	Delta Mode Off	
RCF(N)(F)	Move Reference Cursor to Frequency F	
RCP(P)	Move Reference Cursor to Position P	
SEARCH FACILITY		
CMX(N)	Move Cursor to Max	General cursor search on channel N. The cursor will be moved to either the maximum or minimum trace position, a specific marker, or the active marker.
CMN(N)	Move Cursor to Min	
CMK(M)	Move Cursor to Marker M	
CAM	Move Cursor to Active Marker	
CLT(N)(n)	Move Cursor Left to n dB	If the delta mode is off, then the search will be for an absolute value left or right of the cursor. If the delta mode is on, the search will be for a value relative to the current reference cursor value.
CRT(N)(n)	Move Cursor Right to n dB	
CBW(N)(n)	Bandwidth	Displays the bandwidth of value n dB on channel N. The reference cursor is left at the lower frequency and the main cursor at the higher.
XCG	Exchange Cursor And Reference Cursor	Reverses the positions of the main cursor and the reference cursor.

Table 4-6. Command Codes: Hard Copy

The following is a list of Mnemonic parameters as indicated within parenthesis: N = 1 or 2 for channel selection n = a number within range +/-99.99 F = a frequency within range +/-0 to 999.9999 GHz S = 0 or 1 for ON/OFF indication (1 = ON, 0 = OFF) M = 1 to 9, Marker numbers, used for SAVE, RECALL, STORE Marker#, etc. P = 0 to 400, to select pixel position X = a variable that will be defined next to the instruction or Mnemonic		
COMMAND CODE	MNEMONIC	FUNCTION
PST	Stop Plot/Print	Stops the plotting/printing of hard copy.
PGR	Print Graph	Dumps the current graph displayed on the screen to the Centronics printer.
PT(X)	Print Tabular Data	Where X = 1 – 5. When X = 5 tab data prints only at the markers X = 0 Screen dumps 401 data points. X = 1 Screen dumps 201 data points. X = 2 Screen dumps 101 data points. X = 3 Screen dumps 51 data points. X = 4 Screen dumps 26 data points.
PLA	Plot All	Provides a screen plot containing trace, graticule, cursor, and titles.
PLR	Plot Trace	Provides a screen plot of the signal trace(s).
PLG	Plot Graticule	Provides a screen plot of the graticule and reference lines.
PLC	Plot Cursor	Provides a plot of the current cursor position.
PLT	Plot Titles	Provides a plot of the current titles displayed to indicate the measurement and test being performed.
PC	Output Custom Plot	Always plots the user specified plot. If PC is used and not defined, the 561 defaults to "Plot Fail."
SCP "bit mask"	Specify Custom Plot	The bit mask (Figure 4-6) is a string of ASCII 0's and 1's that indicate the user's requirements for a plot (e.g., title strings, markers, traces, graticules, etc).
LID 'Ident' LDE 'Device' LDA 'Date'	Set LID identification Set Test Device Label Set Date	The name of the operator or test device serial number, the test device used, and the date will be printed for all Centronics prints containing header or title information. EXAMPLE: LID 'A. WILKINS', causes the operator's name, to be printed on any printer using a Centronics interface.

Bus Command: SCP (mask)

The "mask" is a 16-bit ASCII string of 1's and 0's, where the first four characters are zeros. It must be set such so as to select the desired plot function. Mask selection for plot functions as follows:

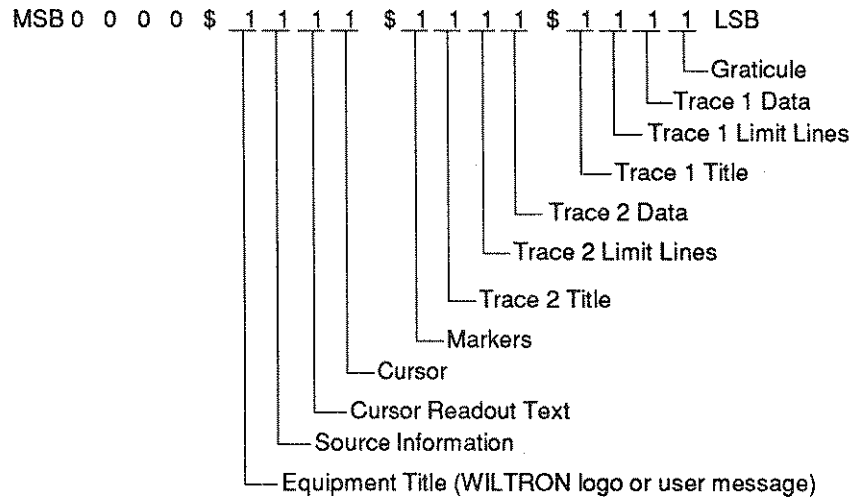

Figure 4-6. Programming Example: SCP (mask)

Table 4-7. Command Codes: Output Functions

The following is a list of Mnemonic parameters as indicated within parenthesis: N = 1 or 2 for channel selection n = a number within range +/-99.99 F = a frequency within range +/-0 to 999.9999 GHz S = 0 or 1 for ON/OFF indication (1 = ON, 0 = OFF) M = 1 to 9, Marker numbers, used for SAVE, RECALL, STORE Marker#, etc. P = 0 to 400, to select pixel position X = a variable that will be defined next to the instruction or Mnemonic		
COMMAND CODE	MNEMONIC	FUNCTION
OCF(N)	Output Cursor Frequency	Returns the cursor frequency from channel N.
OCR(N)	Output Cursor Readout	Returns the cursor value in dB for the current cursor trace position.
OCP	Output Cursor Position	Returns the current cursor position.
ODF(N)	Output Delta Cursor Frequency	Returns the frequency difference between the reference cursor and the main cursor for channel N.
ODR(N)	Output Delta Cursor Readout	Returns the readout difference between the reference cursor value and the main cursor value for channel N.
OEB	Output Extended Status Byte	Returns and ASCII representation of the extended status byte to the controller.
OPM(X)	Output Parameter X	Returns parameter X to the controller. Parameter X is defined in Figure 4-7.
OID	Output Identify	Returns the 561's identity string.
OPB	Output Primary Status Byte	Returns the primary status byte to the controller.
ORB	Output Redirected Status Bytes	Returns an SRQ generated on the dedicated GPIB (sweeper, plotter, etc.) along with the address of the instrument that caused it, when next addressed to talk.
ORD	Output Redirected Data	Returns the last data that was requested from an instrument on the dedicated bus by an RDR command.
ORP	Output Reference Cursor Position	Causes the 561 to output the reference cursor position when next addressed to talk.

1	Offset Channel 1 (dB)
2	Offset Channel 2 (dB)
3	Sensitivity Channel 1 (dB/Div)
4	Sensitivity Channel 2 (dB/Div)
5	High Limit Channel 1 (dB)
6	Low Limit Channel 1 (dB)
7	High Limit Channel 2 (dB)
8	Low Limit Channel 2 (dB)
9	Sweeper Start Frequency (GHz)
10	Sweeper Stop Frequency (GHz)
11	561 GPIB Address
12	Sweeper GPIB Address
13	Reserved
14	Marker M1 Frequency (GHz)
15	Marker M2 Frequency (GHz)
16	Marker M3 Frequency (GHz)
17	Marker M4 Frequency (GHz)
18	Marker M5 Frequency (GHz)
19	Marker M6 Frequency (GHz)
20	Marker M7 Frequency (GHz)
21	Marker M8 Frequency (GHz)
22	Reserved
23	Power Level From Sweeper (dBm)
24	Reserved
25	Reserved
26	dB/Sweep Value (dB)
27	Cursor Position
28	Reference Cursor Position
29	Plotter Address Parameter
30	Reserved
31	Graticule Spacing (GHz/Div)
32	Reserved
33	Reading At Cursor for Channel 1
34	Reading At Cursor for Channel 2
35	Alternate Start Frequency (GHz)
36	Alternate Stop Frequency (GHz)
37	Alternate Power Sweep Level (dB)
38	Alternate Power Level (dBm)
39	Reserved
*40	Last Value for Move Cursor Right, Channel 1
*41	Last Value for Move Cursor Left, Channel 1
*42	Last Value for Bandwidth Search, Channel 1
*43	Last Value for Move Cursor Right, Channel 2
*44	Last Value for Move Cursor Left, Channel 2
*45	Last Value for Bandwidth Search, Channel 2
*46	Delta Mode, Last Value for Move Cursor Right, Channel 1
*47	Delta Mode, Last Value for Move Cursor Left, Channel 1
*48	Delta Mode, Last Value for Bandwidth Search, Channel 1
*49	Delta Mode, Last Value for Move Cursor Right, Channel 2
*50	Delta Mode, Last Value for Move Cursor Left, Channel 2
*51	Last Value for Bandwidth Search, Channel 2

*These parameters will only be updated when entered from the front panel.

Figure 4-7. Available Parameters, OPM(X)

Table 4-8. Command Codes: Data Strings

The following is a list of Mnemonic parameters as indicated within parenthesis: N = 1 or 2 for channel selection n = a number within range +/-99.99 F = a frequency within range +/-0 to 999.9999 GHz S = 0 or 1 for ON/OFF indication (1 = ON, 0 = OFF) M = 1 to 9, Marker numbers, used for SAVE, RECALL, STORE Marker#, etc. P = 0 to 400, to select pixel position X = a variable that will be defined next to the instruction or Mnemonic		
COMMAND CODE	MNEMONIC	FUNCTION
OAT(N)	Output ASCII Trace	Returns an ASCII representation of the signal trace data for channel N.
OBT(N)	Output Binary Trace	Returns a binary representation of signal trace data for channel N.
OCD(N)	Output Calibration Data	Returns calibration data for the selected channel to the controller for channel N.
OSS(M)	Output Stored Setup	Returns stored setup M to the controller.
LAT(N)	Learn ASCII Trace	The 561 receives ASCII signal trace data sent from the controller for channel N.
LBT(N)	Learn Binary Trace	The 561 receives binary signal trace data sent from the controller for channel N.
LCD(N)	Learn Calibration Data	The 561 receives calibration data sent from the controller for channel N.
LSS(M)	Learn Stored Setup	The 561 receives stored setup M sent from the controller.

Table 4-9. Command Codes: Pass Through Codes

<p>The following is a list of Mnemonic parameters as indicated within parenthesis: N = 1 or 2 for channel selection n = a number within range +/-99.99 F = a frequency within range +/-0 to 999.9999 GHz S = 0 or 1 for ON/OFF indication (1 = ON, 0 = OFF) M = 1 to 9, Marker numbers, used for SAVE, RECALL, STORE Marker#, etc. P = 0 to 400, to select pixel position X = a variable that will be defined next to the instruction or Mnemonic</p>		
COMMAND CODE	MNEMONIC	FUNCTION
RDB (X)	Pass Through Command for Binary Data	Redirects binary data to an instrument on the dedicated bus.
RDR(X)	Pass Through Command for ASCII Data	Addresses and programs instruments connected to the dedicated GPIB interface, where X is the address of the instrument receiving the data. For example, RDR 5 COMMAND STRING would pass the command string data to any instrument on the dedicated GPIB having address 5. "CR LF" at the end of the pass through command string terminates the data transmission. See Figure 4-8 for a sample program using this command.
SDP(X) SDS(X) SDX(X)	Set Plotter Address Set Sweeper Address Set 561 Address	Sets the plotter, sweeper, or 561 address where X= the new address of the instrument. Valid instrument addresses for X are 0 to 30.

```
100 DISP @DISP @DISP @DISP
110 DISP "Version 1: 10-SEP-87"
120 WAIT 12000
130 OUTPUT A ; "RST"
140 OUTPUT A ; "CH1 0, CH2 0, GOF"
150 OUTPUT A ; "RDR 5, CS1, FL1, F050MH, SWT50MS, CF0"
160 OUTPUT R ; "RDR 5, MK0, LVL2DM, RT1"
170 CLEAR @DISP
180 DISP TAB(7) ; "TEST SEQUENCE MENU" @DISP
190 DISP TAB(3) ; "0 = EXIT PROGRAM"
200 DISP TAB(3) ; "1 = P/M DATA"
210 DISP TAB(3) ; "2 = SIG CHAN, RF ON"
220 DISP TAB(3) ; "3 = SIG CHAN, RF OFF"
230 DISP TAB(3) ; "4 = SIG CHAN, RF ON & OFF"
240 DISP TAB(3) ; "5 = ALL"
250 DISP @ DISP TAB(2) ; "SELECT OPTION BY NUMBER";
260 BEEP 100, 30
260 INPUT N
270 IF N OR N5 THEN GOTO 290
280 IF N1 THEN GOTO 420 ELSE GO TO 450
290 CLEAR @ DISP @ DISP @ DISP @ DISP @ DISP
```

RDR 5 redirects the following command sequence to the sweep generator, which is at GPIB address 5. The coding in line 150 commands the sweeper to do the following:

- Turn the horizontal sweep on during CW operation.
- Turn the CW filter on.
- Set F0 to 50 MHz.
- Set a sweep time of 50 ms.
- Set F0 for CW operation.

For Line 160, RDR does the following:

- Turns off the markers.
- Sets internal leveling for 2 dBm.
- Turns the RF on during retrace.

Figure 4-8. Sample Program: RDR Command

Table 4-10. Command Codes: General Functions

COMMAND CODE	MNEMONIC	FUNCTION
ARF(S)	Autozero RF Mode On/Off	Autozero occurs every retrace. This establishes if the 561 is to expect the RF to still be on (in which case zeroing is performed using dummy loads) or off (zeroing is performed at the detectors).
BC(S)	Blank CRT	Either blanks (BUS COMMAND = BC1), or unblanks (BUS COMMAND = BC0) the CRT display.
CTN	Continue	Continues to next calibration step, or continues after self test failed.
HON HOF	Hold Enable Release Hold	Holds the current data being displayed on the screen. Continue displaying measurement data.
NUL	Low Level Null	Used in conjunction with autozero RF mode on to establish an equality between dummy loads and actual RF off conditions (when no RF present). Used to calibrate the dummy load.
RTL	Return To Local	Returns the analyzer from the GPIB mode to the local mode.

Table 4-11. Bus Messages, 561 Recognized by the 561 Network Analyzer

BUS MESSAGES	HOW MESSAGE IS USED BY THE RF ANALYZER
Device Clear	Resets the network analyzer to its default state. Sending this message is equivalent to sending the RST command.
Go to Local	Returns the network analyzer to local (control panel) control.
Group Execute	No action.
Interface Clear	Stops the network analyzer GPIB interface from listening or talking. The front panel controls are not cleared, however.
Local Lockout	Prevents the front panel RETURN TO LOCAL key from returning the network analyzer to local (control panel) control.
Remote Enable	<p>Places the network analyzer under remote (GPIB) control if the REM line is TRUE and the network analyzer has been addressed to listen.</p> <p style="text-align: center;">NOTE</p> <p>If the network analyzer is placed in remote and not supplied with program data, its operation is determined by the positions in which the front panel controls were set immediately prior to going remote.</p>
Service Request Messages Serial-Poll (SPE) Serial-Poll Disable (SPD)	<p>The network analyzer has been equipped with an SRQ capability. It will respond to both serial- and parallel-poll messages. Responses to these messages are described below.</p> <p>The SPE message causes the network analyzer to respond with a Enable (SPE) decimally-coded status byte.</p> <p>The SPD message, which the controller sends, terminates a serial poll operation.</p>
Parallel Poll Operation Parallel-Poll Configure (PPC) Parallel-Poll ENABLE (PPE) Parallel-Poll Unconfigure (PPU), Disable (PPD)	<p>When queried by a parallel-poll message (PPOLL, Table 4-4), the network analyzer (if configured for parallel-poll operation) responds by setting its assigned data bus line to the logical state (1, 0) that indicates its correct SRQ status. To configure a bus device that is (1) built for parallel-poll operation and (2) designed to be remotely configured via the bus, the controller sends a two-byte parallel-poll configure and enable (PPC and PPE) message.</p> <p>The PPC byte configures the device to respond to a parallel- poll message, such as PPOLL.</p> <p>The PPE byte assigns the logical sense (1, 0) that the parallel- Enable (PPE) poll response will take.</p> <p>When the network analyzer receives the PPC/PPE message, it configures itself to properly respond to the parallel-poll message. The PPU or PPD message is sent by the controller when a parallel-poll response is no longer needed. This message disable causes the network analyzer to become unconfigured for a parallel-poll response.</p>

Table 4-12. Methods of Generating Bus Commands

FUNCTION	METHOD OF EXECUTION	
	WILTRON 85	HP SERIES 200
Go to Local (GTL)	LOCAL 6 * LOCAL 706	LOCAL 6 LOCAL 706
Group Execute Trigger	TRIGGER 6 TRIGGER 706	TRIGGER 6 (GET) TRIGGER 706
Interface Clear (IFC)	ABORTIO 6	ABORT 6
Device Clear (DC) (SDC)	CLEAR 6 CLEAR 706	CLEAR 6 CLEAR 706
Local Lockout (LLO)	LOCAL LOCKOUT 6	LOCAL LOCKOUT 6
Remote Enable (REN)	REMOTE 6 REMOTE 706	REMOTE 6 REMOTE 706
Serial Poll	A=SPOLL (706)	A=SPOLL (706)
Parallel Poll Configure (PPC)	SEND 6; UNL LISTEN 6 CMD 3 SCG 6	PPOLL CONFIGURE 706;6
Parallel Poll	A=PPOLL (6)	A=PPOLL (6)
Parallel Poll Unconfigure (PPU)	SEND 6; CMD 21 SEND 6; UNL LISTEN 6 CMD 21	PPOL UNCONFIGURE 6 PPOL UNCONFIGURE 706

* Assumes GPIB address set to 6.

Table 4-13. Alphabetical Index to the Command Codes

The following is a list of mnemonic parameters as indicated within parenthesis:

N = 1 or 2 for channel selection

n = a number within range +/-99.99

F = a frequency within range +/-0 to 999.9999 GHz

S = 0 or 1 for ON/OFF indication (1 = ON, 0 = OFF)

M= 1 to 9, Marker numbers, used for SAVE, RECALL, STORE Marker #, etc.

P = 0 to 400, to select pixel position

X = a variable that will be defined next to the instruction or Mnemonic

COMMAND CODE	NAME	PAGE NUMBER	COMMAND CODE	NAME	PAGE NUMBER
AOF	Averaging Off	4-9	HON	Hold On	4-19
ARF(S)	Autozero RF On\Off	4-19	HOF	Hold Off	4-19
ASC(N)	Autoscale	4-7	IPM(X)	Input Primary Mask	4-9
AVG(X)	Averaging On	4-9	IEM(X)	Input Extended Mask	4-9
BC(S)	Blank CRT	4-19	LAT(N)	Learn ASCII Trace	4-16
CAL	Calibrate the 561	4-8	LBT(N)	Learn Binary Trace	4-16
CAM	Move Cursor To Active Marker	4-11	LCD(N)	Learn Calibration Data	4-16
CBW(N)(n)	Move Cursor To Show Bandwidth	4-11	LDA "date"	Label For Date	4-12
CH1(S)	Set Channel 1 On\Off	4-6	LDE "device"	Label For Test Device	4-12
CH2(S)	Set Channel 2 On\Off	4-6	LHI(N)(n)	High Limit (On)	4-7
CLH(N) (limit values)	Enter High Complex Limits	4-7	LHF(N)	High Limit (Off)	4-7
CLL(N) (limit values)	Enter Low Complex Limits	4-7	LLO(N)(n)	Low Limit (On)	4-7
CLT(N)(n)	Move Cursor Left To n dB	4-11	LLF(N)	Low Limit (Off)	4-7
CMK(M)	Move Cursor To Marker M	4-11	LID "ident"	Label For Identification	4-12
CMN(N)	Move Cursor To Min	4-11	LSS	Learn Stored Setup	4-16
CMX(N)	Move Cursor To Max	4-11	MHz	Reserved Mnemonic	4-12
COF	Cursor Off	4-11	NUL	Low Level Null	4-19
CON	Cursor On	4-11	OAT(N)	Output ASCII Trace Data	4-16
CRF(N)(F)	Move Cursor To Frequency F On Channel N	4-11	OBT(N)	Output Binary Trace Data	4-16
CRT(N)(n)	Move Cursor Right To n dB	4-11	OCD(N)	Output Calibration Data	4-16
CRP(P)	Move Cursor To Position P	4-11	OCF(N)	Output Cursor Frequency	4-14
CSB	Clear Primary Status Byte	4-9	OCN	Output Cursor Position	4-14
CTN	Continue to Next Calibration Step, or Continue after Self Test Failed	4-19	OCR(N)	Output Cursor Readout	4-14
dB	Reserved Mnemonic	4-5	ODF(N)	Output Delta Cursor Frequency	4-14
dBm	Reserved Mnemonic	4-5	ODR(N)	Output Delta Cursor Readout	4-14
DLT	Display Limits Test	4-7	OEB	Output Extended Status Byte	4-14
DOF	Delta Mode Off	4-11	OFF(N)(n)	Set Channel Offset (dB)	4-6
DON	Delta Mode On	4-11	OID	Output Identify	4-14
DP1	Set Resolution To 101 Data Points	4-8	OLT(N)	Output Limits Test Result	4-7
DP2	Set Resolution To 201 Data Points	4-8	OPM(X)	Output Parameter X	4-14
DP4	Set Resolution To 401 Data Points	4-8	OPB	Output Primary Status Byte	4-14
GHz	Reserved Mnemonic	4-12	ORB	Output Redirected Status Bytes	4-14
GON	Display Graticule	4-8	ORD	Output Redirected Data	4-14
GOF	Turn Off Graticule Display	4-8	ORP	Output Reference Cursor Position	4-14
GSF	GPIB Status Indication Off	4-7	OSS	Output Stored Setup	4-16
GSN	GPIB Status Indication On	4-7	PC	Output Custom Plot	4-12
			PGR	Print Graph	4-12
			PLA	Plot All	4-12
			PLC	Plot Cursor	4-12
			PLG	Plot Graticule	4-12
			PLR	Plot Trace	4-12
			PLT	Plot Titles	4-12

Table 4-13. Alphabetical Index to the Command Codes (Continued)

COMMAND CODE	NAME	PAGE NUMBER	COMMAND CODE	NAME	PAGE NUMBER
PRV(X)	Preview	4-8	SDX(X)	Set 561 Address	4-17
PST	Stop Print	4-12	SI1 (input comb.)	Set Input For Channel 1	4-6
PT(X)	Print Tab Data	4-12	SI2 (input comb.)	Set Input For Channel 2	4-6
RCC(X)	Recall With Calibration Data	4-8	SM1(X)	Set Channel 1 Measurement Display	4-6
RCF(N)(F)	Move Reference Cursor To Frequency	4-11	SM2(X)	Set Channel 2 Measurement Display	4-6
RDB(X)	Pass Through Command For Binary Data	4-17	SOF	Smoothing Off	4-9
RDR(X)	Pass Through Command For ASCII Data	4-17	SON(X)	Smoothing On	4-9
RCP(P)	Move Reference Cursor To Position P	4-11	SQ0	Disable SRQs	4-9
RCS(M)	Recall Front Panel Setup	4-8	SQ1	Enable SRQs	4-9
REF(N)(X)	Set Reference Line Position	4-6	SQS(X)	Program Number of Sweeps	4-9
ROF(N)	Reference Line Display Off	4-6	SVC(X)	Save Setup With Calibration Data	4-8
RON(N)	Reference Line Display On	4-6	SVS(M)	Save Front Panel Setup	4-8
RST	Reset Instrument	4-8	TCR(N)	Adjust Offset So That The Trace At The Cursor Moves To The Ref. Line	4-6
RTL	Return To Local	4-19	TST	Run Instrument Test Routine	4-8
SCL(N)(X)	Set Resolution (dB/Div.)	4-6	XCG	Exchange Cursor & Reference Cursor	4-11
SCP(bit mask)	Specify Custom Plot	4-12			
SDP(X)	Set Plotter Address (Dedicated GPIB)	4-17			
SDS(X)	Set Sweeper Address (Dedicated GPIB)	4-17			

